

# LA MAISON

FURNITURE, LIGHTING AND RUGS

GENERAL CATALOGUE  
2024 / 2025





















































# Product categories

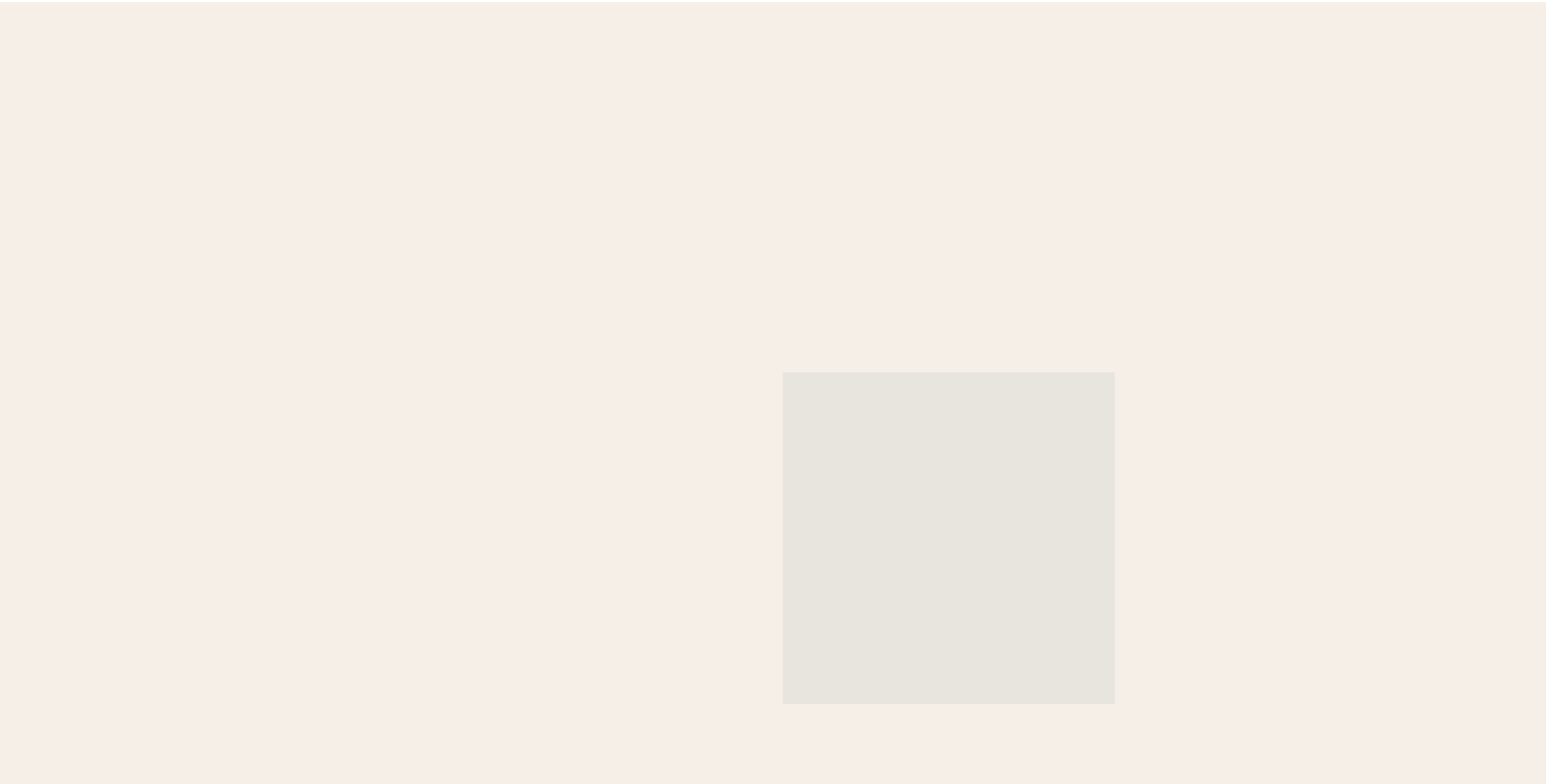

## Sofas & chaise lounges

## Armchairs & stools





## Coffee tables & occasional furniture

## Chairs & tables

## Singular furniture

## Desks & consoles

# Carpets

# Lighting

# Collections

CARPETS

FURNITURE

LIGHTING

APPENDIX

## CARPETS

### Cordélie

## FURNITURE

Ancelle d'Hermès  
Atout d'Hermès  
Chaise Conservatoire  
Contour d'Hermès  
Équilibre d'Hermès  
Équipages d'Hermès  
Equis d'Hermès  
Hippodrome d'Hermès  
Karumi  
The Sellier Chair  
Les Nécessaires d'Hermès  
Les Trotteuses d'Hermès  
Lignage d'Hermès  
Métiers  
Oria d'Hermès  
Persiennes  
Pippa  
Jean-Michel Frank furniture  
designs by Hermès  
Sillage d'Hermès  
Sofa Sellier  
Tray-Tôt

## LIGHTING

Coulisse  
Halo  
Hécate  
Harnais  
Lanterne d'Hermès  
Pantographe  
Sarazine

# Cordélie

Entirely hand-embroidered, Cordélie carpets are the fruit of a long crafting process based on exceptional know-how. A cotton cord is applied on a linen backing using an embroidering hook to draw – as with a pencil – lines and flat planes of geometric compositions.

Designer Hermès Studio



# Arçon carpet Cordélie

## Arçon carpet

Hand-embroidered cotton cord.  
Design: Arçon de Pierre Charpin.

Designer: Hermès Studio Made in India

- + Cordélie carpets draw their name from the embroidery technique that's used in crafting them, the Cornely stitch.



Osier / terracotta, 103703M 01



Chatain / clémentine, 103703M 02



Indigo / orange / kaki, 103703M 03



Mousse / acajou / mordoré, 103703M 04

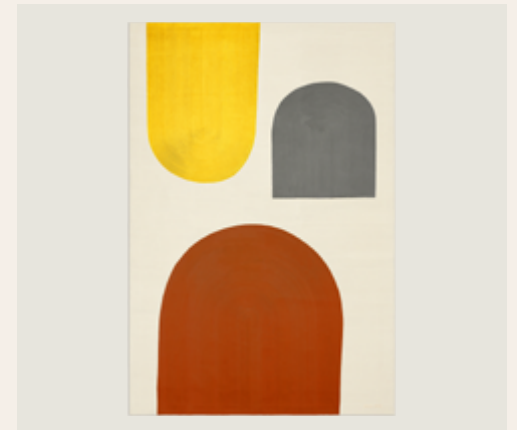

Terre de Sienna / soleil / gris, 103703M 05

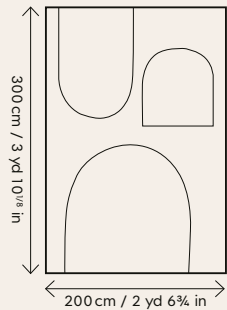

Custom sizing available

# Arçon carpet Cordélie



## References

### MATERIALS

### Cotton

### COLOURS

Osier / terracotta	103703M 01
Chatain / clémentine	103703M 02
Indigo / orange / kaki	103703M 03
Mousse / acajou / mordoré	103703M 04
Terre de Sienne / soleil / gris	103703M 05

### Important to know

- A fine cotton cord is applied to an extremely robust linen backing, tracing the lines of the Cordélie carpets.
- It is a rare and painstaking embroidery technique. Different variations of size are available, as a semi-bespoke service.

### Care advice

- To preserve your rug we recommend that you apply an anti-stain treatment and have it dry-cleaned regularly. Do not under any circumstances use water-based, deep-steam or bonnet cleaning methods. In the case of spills or splashes, use a dry cloth to absorb as much of the liquid as possible in order to limit its penetration into the fibres. Do not use salt. If you have concerns or questions, please contact your Hermès store.

### Packing information

1 package with a total weigh of 15 kg.  
Package size: 220 x 20 x 20 cm.

# H o x e r carpet Cordélie

## H o x e r carpet

Hand-embroidered cotton cord.  
Design: H o x e r de Pierre Charpin.

Designer: Hermès Studio Made in India

+ Cordélie carpets draw their name from the embroidery technique that's used in crafting them, the Cornely stitch.



Encre / vanille / miel, 103704M 01



Osier / cyprès / clémentine / saphir 103704M 02



Acajou / olive / châtain / craie, 103704M 03

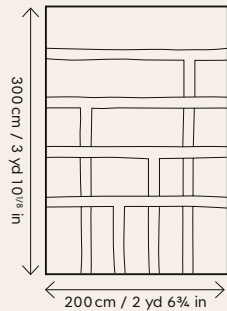

Custom sizing available

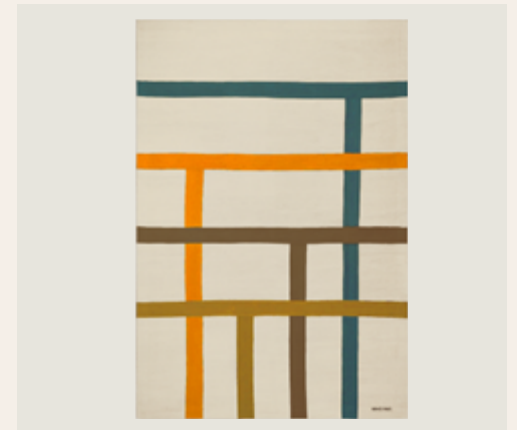

Écru / ocre / noisette / bleu givre, 103704M 04

# H oxer carpet Cordélie

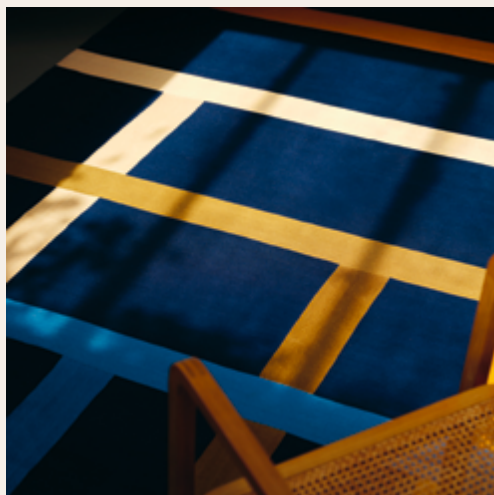

## References

### MATERIALS

### Cotton

### COLOURS

Encre / vanille / miel	103704M 01
Osier / cyprès / clémentine / saphir	103704M 02
Acajou / olive / châtain / craie	103704M 03
Écru / ocre / noisette / bleu givre	103704M 04

### Important to know

- A fine cotton cord is applied to an extremely robust linen backing, tracing the lines of the Cordélie carpets.
- It is a rare and painstaking embroidery technique. Different variations of size are available, as a semi-bespoke service.

### Care advice

- To preserve your rug we recommend that you apply an anti-stain treatment and have it dry-cleaned regularly. Do not under any circumstances use water-based, deep-steam or bonnet cleaning methods. In the case of spills or splashes, use a dry cloth to absorb as much of the liquid as possible in order to limit its penetration into the fibres. Do not use salt. If you have concerns or questions, please contact your Hermès store.

### Packing information

1 package with a total weigh of 15 kg.  
Package size: 220 x 20 x 20 cm.

# Parcours carpet Cordélie

## Parcours carpet

Hand-embroidered cotton cord.  
Design: Parcours de Pierre Charpin.

Designer: Hermès Studio Made in India

- + Cordélie carpets draw their name from the embroidery technique that's used in crafting them, the Cornely stitch.



Mordore / mousse, 103711M 01



Marine / sapin / cacao, 103711M 02



Pétrole / sable / gold / or, 103711M 03

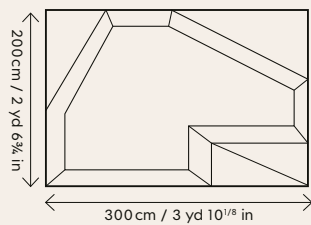

Custom sizing available



Roux / osier / framboise / clémentine, 103711M 04

# Parcours carpet Cordélie



## References

### MATERIALS

### Cotton

### COLOURS

Mordore / mousse	103711M 01
Marine / sapin / cacao	103711M 02
Pétrole / sable / gold / or	103711M 03
Roux / osier / framboise / clémentine	103711M 04

### Important to know

- A fine cotton cord is applied to an extremely robust linen backing, tracing the lines of the Cordélie carpets.
- It is a rare and painstaking embroidery technique. Different variations of size are available, as a semi-bespoke service.

### Care advice

- To preserve your rug we recommend that you apply an anti-stain treatment and have it dry-cleaned regularly. Do not under any circumstances use water-based, deep-steam or bonnet cleaning methods. In the case of spills or splashes, use a dry cloth to absorb as much of the liquid as possible in order to limit its penetration into the fibres. Do not use salt. If you have concerns or questions, please contact your Hermès store.

### Packing information

1 package with a total weigh of 15 kg.  
Package size: 220 x 20 x 20 cm.

# Escalator carpet Cordélie

## Escalator carpet

Hand-embroidered cotton cord.  
Design: Escalator Gianpaolo Pagni.

Designer: Hermès Studio  
Made in India

- + Cordélie carpets draw their name from the embroidery technique that's used in crafting them, the Cornely stitch.



Terracotta / marine, 210051M 01



Ficelle / orange, 210051M 02



Encre / gold, 210051M 03



Sapin / bleu denim, 210051M 04



Pétrole / tabac, 210051M 05

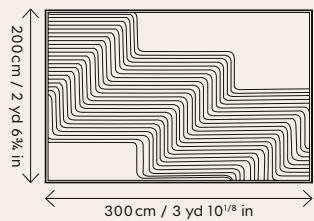

Custom sizing available



# Escalator carpet Cordélie



## References

### MATERIALS

Cotton

### COLOURS

Terracotta / indigo

Ficelle / orange

Encre / gold

Sapin / bleu denim

Pétrole / tabac

210051M 01

210051M 02

210051M 03

210051M 04

210051M 05

## Important to know

- A fine cotton cord is applied to an extremely robust linen backing, tracing the lines of the Cordélie carpets.
- It is a rare and painstaking embroidery technique. Different variations size are available, as a semi-bespoke service.

## Care advice

- To preserve your rug we recommend that you apply an anti-stain treatment and have it dry-cleaned regularly. Do not under any circumstances use water-based, deep-steam or bonnet cleaning methods. In the case of spills or splashes, use a dry cloth to absorb as much of the liquid as possible in order to limit its penetration into the fibres. Do not use salt. If you have concerns or questions, please contact your Hermès store.

## Packing information

1 package with a total weigh of 15 kg.  
Package size: 220 x 20 x 20 cm.



# H Vibration carpet Cordélie

## H Vibration carpet

Hand-embroidered cotton cord.  
Design: H Vibration Studio Hermès

Designer: Hermès Studio  
Made in India

+ Cordélie carpets draw their name from the embroidery technique that's used in crafting them, the Cornely stitch.



Cypres / brun, 210052M 01



Châtaigne / encre, 210052M 02



Terracotta / café, 210052M 03

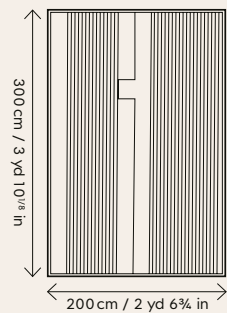

L 300 × H 200cm  
3 yd 10<sup>7</sup>/<sub>8</sub> in. × 2 yd 6<sup>3</sup>/<sub>4</sub> in  
Custom sizing available



Marine / ocre, 210052M 04

# H Vibration carpet Cordélie

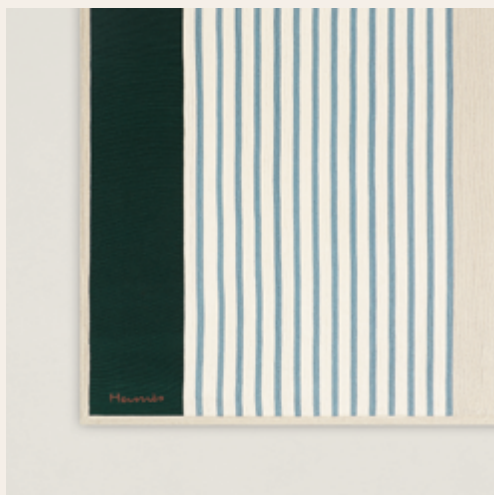

## References

### MATERIALS

### Cotton

### COLOURS

Cyprès / brun	210052M 01
Châtaigne / encre	210052M 02
Terracotta / café	210052M 03
Marine / ocre	210052M 04

## Important to know

- A fine cotton cord is applied to an extremely robust linen backing, tracing the lines of the Cordélie carpets.
- It is a rare and painstaking embroidery technique. Different variations of size are available, as a semi-bespoke service.

## Care advice

- To preserve your rug we recommend that you apply an anti-stain treatment and have it dry-cleaned regularly. Do not under any circumstances use water-based, deep-steam or bonnet cleaning methods. In the case of spills or splashes, use a dry cloth to absorb as much of the liquid as possible in order to limit its penetration into the fibres. Do not use salt. If you have concerns or questions, please contact your Hermès store.

## Packing information

1 package with a total weigh of 15 kg.  
Package size: 220 x 20 x 20 cm.

# Tremplin carpet Cordélie

## Tremplin carpet

Hand-embroidered cotton cord.  
Design: Tremplin Gianpaolo Pagni

Designer: Hermès Studio  
Made in India

- + Cordélie carpets draw their name from the embroidery technique that's used in crafting them, the Cornely stitch.



Mordoré / orange, 210050M 01



Noisette / soleil, 210050M 02



Terre de Sienne / denim, 210050M 03

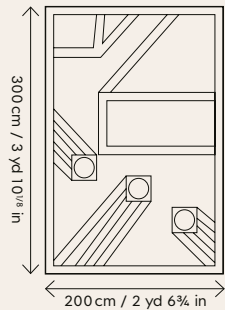

L 300 × H 200cm  
3 yd 10<sup>7</sup>/<sub>8</sub> in. × 2 yd 6<sup>3</sup>/<sub>4</sub> in  
Custom sizing available



Marine / carmin, 210050M 04



Sapin / miel, 210050M 05

# Tremplin carpet Cordélie



## References

### MATERIALS

### Cotton

### COLOURS

Mordoré / orange	210050M 01
Noisette / soleil	210050M 02
Terre de sienne / denim	210050M 03
Marine / carmin	210050M 04
Sapin / miel	210050M 05

### Important to know

- A fine cotton cord is applied to an extremely robust linen backing, tracing the lines of the Cordélie carpets.
- It is a rare and painstaking embroidery technique. Different variations of size are available, as a semi-bespoke service.

### Care advice

- To preserve your rug we recommend that you apply an anti-stain treatment and have it dry-cleaned regularly. Do not under any circumstances use water-based, deep-steam or bonnet cleaning methods. In the case of spills or splashes, use a dry cloth to absorb as much of the liquid as possible in order to limit its penetration into the fibres. Do not use salt. If you have concerns or questions, please contact your Hermès store.

### Packing information

1 package with a total weigh of 15 kg.  
Package size: 220 x 20 x 20 cm.

## CARPETS

Cordélie

## FURNITURE

### Ancelle d'Hermès

Atout d'Hermès  
Chaise Conservatoire  
Contour d'Hermès  
Équilibre d'Hermès  
Équipages d'Hermès  
Equis d'Hermès  
Hippodrome d'Hermès  
Karumi  
The Sellier Chair  
Les Nécessaires d'Hermès  
Les Trotteuses d'Hermès  
Lignage d'Hermès  
Métiers  
Oria d'Hermès  
Persiennes  
Pippa  
Jean-Michel Frank furniture  
designs by Hermès  
Sillage d'Hermès  
Sofa Sellier  
Tray-Tôt

## LIGHTING

Coulisse  
Halo  
Hécate  
Harnais  
Lanterne d'Hermès  
Pantographe  
Sarazine

# Ancelle d'Hermès

Conceived by Danish designer Cecilie Manz, the Ancelle d'Hermès armchair is compellingly direct: its powerful frame in solid wood is combined with a sheet of leather that creates a light and elegant seat. Heir to a Scandinavian tradition that merges robustness with minimalism, this armchair offers an elegant, structured look.

Creation Cecilie Manz, Danish designer

# Armchair Ancelle d'Hermès

## Armchair

Structure in natural solid oak.  
Seat in natural cowhide slats lined with natural linen canvas.

Creation: Cecilie Manz  
Made in France

+ An metal core reinforces the seat.



Armchair, 961829M 01

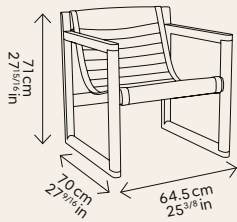

H seat base: 40.5 cm / 15<sup>15</sup>/<sub>16</sub> in  
H armrest: 61 cm / 24 in

# Armchair Ancelle d'Hermès



## Reference

### WOOD

Solid oak

### LEATHER

Natural cowhide

961829M 01

## Care advice

- To maintain the quality of this product over time, clean regularly with a soft cloth and wipe off any stains immediately with a clean, absorbent cloth.
- For any other maintenance request, please contact Hermès Customer Service.

## Packing information

1 package with a total weight of 73 kg.  
Package size: 900 x 770 x 116 cm  
(35<sup>7/16</sup> x 30<sup>5/16</sup> x 45<sup>43/64</sup> in).

## CARPETS

Cordélie

## FURNITURE

Ancelle d'Hermès

**Atout d'Hermès**

Chaise Conservatoire

Contour d'Hermès

Équilibre d'Hermès

Équipages d'Hermès

Equis d'Hermès

Hippodrome d'Hermès

Karumi

The Sellier Chair

Les Nécessaires d'Hermès

Les Trotteuses d'Hermès

Lignage d'Hermès

Métiers

Oria d'Hermès

Persiennes

Pippa

Jean-Michel Frank furniture

designs by Hermès

Sillage d'Hermès

Sofa Sellier

Tray-Tôt

## LIGHTING

Coulisse

Halo

Hécate

Harnais

Lanterne d'Hermès

Pantographe

Sarazine

# Atout d'Hermès

The simple lines of this games table contrast with the sumptuous details, craftsmanship and materials featured in the central chest. This table in natural oak or walnut wood incorporates two reversible games surfaces in leather marquetry. These surfaces are perfect for cards, chess, draughts, or backgammon, and include concealed compartments sheathed in H bull calf for storing playing pieces, dice, and counters.

Designer Hermès Studio



# Games table Atout d'Hermès

## Games table

Table in wood oak with 4 drawers.  
Tabletops in leather marquetry:  
H bull calf and smooth bull calf.  
One tabletop with plain front and  
chequered chessboard reverse,  
and a second tabletop for  
backgammon on one side and  
chequered draughts on the other.  
Storage compartment in H bull calf  
leather including playing pieces,  
tokens, cards and cups for draughts,  
chess, backgammon, bridge, tarot,  
poker, dice.

Designer: Hermès Studio  
Made in France

+ In a game of cards, the trump  
("l'atout") beats all others.



Natural oak and fauve H bull calf version, 960178M 01



Canaletto walnut and chocolat H bull calf version, 960235M 01

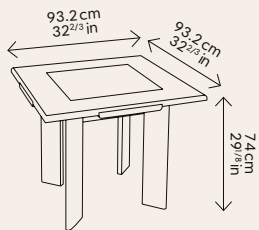

## Games table Atout d'Hermès



Natural oak and fauve H bull calf version, 960178M 01



Canaletto walnut and chocolat H bull calf version, 960235M 01



# Games table Atout d'Hermès

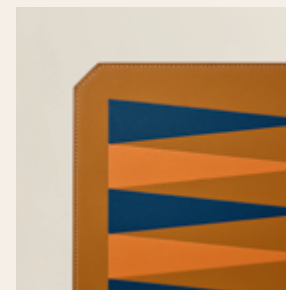
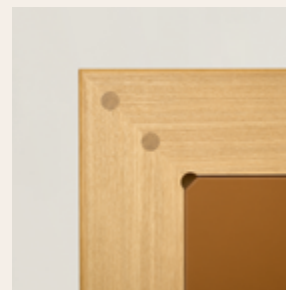

## References

### WOOD

Natural oak

Canaletto walnut

### LEATHER

Fauve H bull calf

Chocolat H bull calf

960178M 01

960235M 01

### Care advice

- Avoid placing the table next to a heat source.
- Keep it away from direct sunlight, moonlight or any other form of harsh light.

### Packing information

- 1 package containing the table with a total weight of 100 kg. Package size: 110x108x100 cm (43<sup>5/16</sup> x 42<sup>1/2</sup> x 39<sup>3/8</sup> in).
- An orange box for the games with a total weight of 100 kg. Package size: 78 x 69,7 x 48,5 cm (30<sup>11/16</sup> x 27<sup>7/16</sup> x 19<sup>1/16</sup> in)

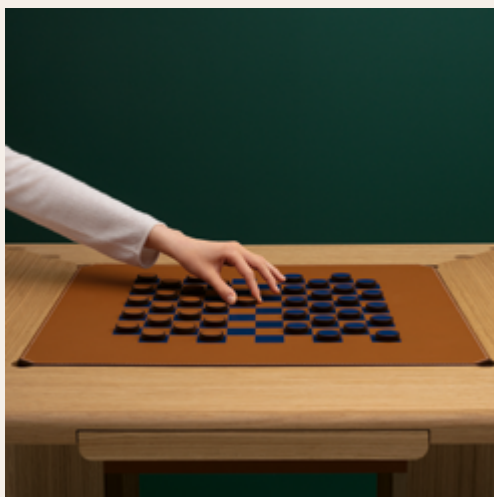

## CARPETS

Cordélie

## FURNITURE

Ancelle d'Hermès

Atout d'Hermès

**Chaise Conservatoire**

Contour d'Hermès

Équilibre d'Hermès

Équipages d'Hermès

Equis d'Hermès

Hippodrome d'Hermès

Karumi

The Sellier Chair

Les Nécessaires d'Hermès

Les Trotteuses d'Hermès

Lignage d'Hermès

Métiers

Oria d'Hermès

Persiennes

Pippa

Jean-Michel Frank furniture

designs by Hermès

Sillage d'Hermès

Sofa Sellier

Tray-Tôt

## LIGHTING

Coulisse

Halo

Hécate

Harnais

Lanterne d'Hermès

Pantographe

Sarazine

# Conservatoire

A chair with an angular, geometric look, sheathed in leather by Hermès in the 1930s, inspired Jasper Morrison to reinterpret it with a light touch. Making the legs slimmer and revising its proportions, the designer has imbued it with a form of modernity. The exceptional leather sheathing of the seat and backrest were faithfully replicated, as was the glossy, glazed heritage leather developed for this creation. The result is a fusion of history, know-how and contemporary attitude.

Creation Jasper Morrison, english designer

# Chair Conservatoire

## Conservatoire chair

Seat and backrest in traditional upholstery sheathed in glazed bullcalf leather, solid oak structure and legs  
Gold

Creation: Jasper Morrison  
Made in France

- + The angle of the backrest on the original chair has been adjusted for optimum seating comfort.
- + A saddle-stitched leather piping around the edge of the chair gives the upholstery a perfect finish.



Gold, 961824M 01



Vert Anglais, 961824M 02



Rouge H, 961824M 03

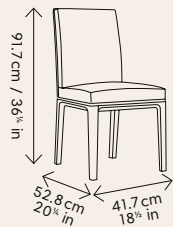

H seat base: 46.5 cm / 18<sup>5/16</sup> in  
D seat base: 39.4 cm / 15<sup>1/2</sup> in

# Chair Conservatoire



## References

WOOD	LEATHER	Worldwide except USA	USA
Natural oak	Glazed bull calf gold	961824MW01	961824MU01
	Glazed bull calf vert anglais	961824MW02	961824MU02
	Glazed bull calf rouge H	961824MW03	961824MU03

## Important to note

- Inner seat structure made from traditional tapestry - with springs and vegetable hair.
- The leather with transparent tanning finish can have a slightly visible veining that enhances the natural look of the hide.

## Care instruction

- To preserve the quality of the furniture over time, it should be cleaned with a soft cloth, and any spills should be wiped up immediately with a clean absorbent cloth.
- For all other maintenance requests, please contact Hermès Customer Service.

## Packing information

1 package with a total weight of 60kg.  
Package size : 62 x 67.8 x 117.2 cm  
(24<sup>7/16</sup> x 26<sup>11/16</sup> x 46<sup>1/8</sup> in).

## CARPETS

Cordélie

## FURNITURE

Ancelle d'Hermès

Atout d'Hermès

Chaise Conservatoire

**Contour d'Hermès**

Équilibre d'Hermès

Équipages d'Hermès

Equis d'Hermès

Hippodrome d'Hermès

Karumi

The Sellier Chair

Les Nécessaires d'Hermès

Les Trotteuses d'Hermès

Lignage d'Hermès

Métiers

Oria d'Hermès

Persiennes

Pippa

Jean-Michel Frank furniture

designs by Hermès

Sillage d'Hermès

Sofa Sellier

Tray-Tôt

## LIGHTING

Coulisse

Halo

Hécate

Harnais

Lanterne d'Hermès

Pantographe

Sarazine

# Contour d'Hermès

Archetypal, timeless, inviting, the Contour d'Hermès sofa puts textiles in the limelight. Upholstered in a wool and cotton slub canvas, it features discreet references to Hermès' leather-crafting heritage.

The buttons that punctuate the cushioned backrest and the piping that emphasizes its lines are in leather, and the legs hidden under the fabric are also leather sheathed and burnished. The quintessential sofa, just as if it had always existed.

Creation Hermès Studio

## 2-seater sofa Contour d'Hermès

### 2-seater sofa

Traditionally upholstered. Beech wood frame. Seat and cushions in flamed canvas. H-taurillon piping and full leather buttons.

Creation: Studio Hermès

Made in France

- + Under its toile flammée, the Contour sofa hides feet sheathed in H bullcalf inspired by the design of the Bouchons from Equipages d'Hermès collection.
- + The seat and back cushions are filled with goose feather down.

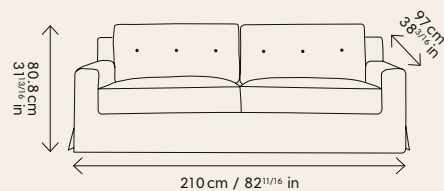

H armrest: 54 cm / 21 1/4 in  
H seat base: 42 cm / 16 5/16 in  
Depth base seat: 65 cm / 25 9/16 in



2-seater sofa, toile flammée, 961828M 01



## 2-seater sofa Contour d'Hermès

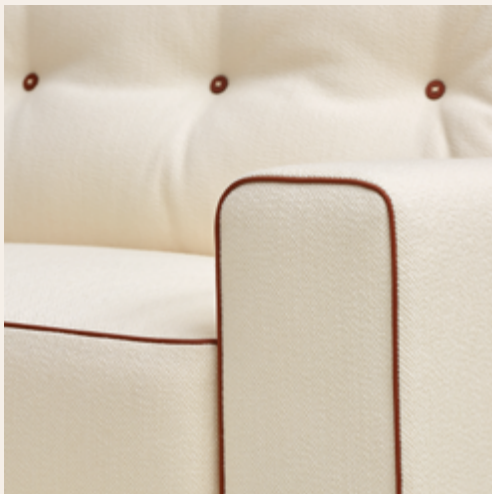

### References

FABRIC	LEATHER	Worldwide except USA	USA
Toile Flammée écru	H bull calf	961828MW01	961828MU01

### Important to note

- Seat and back cushions with removable covers.
- If the cushions seem to sag over time, simply manipulate them and the down will plump up again.

### Care instruction

- To preserve the quality of the furniture over time, it should be cleaned with a soft cloth, and any spills should be wiped up immediately with a clean absorbent cloth.
- For all other maintenance requests, please contact Hermès Customer Service.

### Packing information

1 package with a total weight of 298 kg.  
Package size: 112 x 223 x 97 cm  
(44<sup>1/16</sup> x 87<sup>13/16</sup> x 38<sup>3/16</sup> in).

# 3-seater sofa Contour d'Hermès

## 3-seater sofa

Traditionally upholstered. Beech wood frame. Seat and cushions in flamed canvas. H-taurillon piping and full leather buttons.

Creation: Studio Hermès  
Made in France

- + Under its toile flammée, the Contour sofa hides feet sheathed in H bullcalf inspired by the design of the Bouchons from Equipages d'Hermès collection.
- + The seat and back cushions are filled with goose feather down.

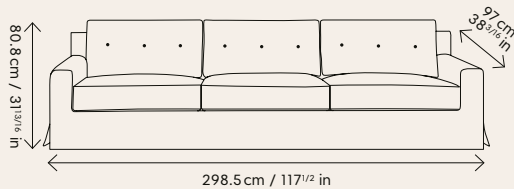

3-seater sofa, toile flammée, 961828M 01

H armrest: 54 cm / 21<sup>1</sup>/<sub>4</sub> in  
H seat base: 42 cm / 16<sup>9</sup>/<sub>16</sub> in  
Depth base seat: 65 cm / 25<sup>9</sup>/<sub>16</sub> in

# 3-seater sofa Contour d'Hermès



## References

FABRIC	LEATHER	Worldwide except USA	USA
Toile Flammée écru	H bull calf	961827MW01	961827MU01

### Important to note

- Seat and back cushions with removable covers.
- If the cushions seem to sag over time, simply manipulate them and the down will plump up again.

### Care instruction

- To preserve the quality of the furniture over time, it should be cleaned with a soft cloth, and any spills should be wiped up immediately with a clean absorbent cloth.
- For all other maintenance requests, please contact Hermès Customer Service.

### Packing information

1 package with a total weight of 371 kg.  
Package size: 112 x 312 x 97 cm  
(44<sup>1/16</sup> x 122<sup>3/16</sup> x 38<sup>3/16</sup> in).

## CARPETS

Cordélie

## FURNITURE

Ancelle d'Hermès  
Atout d'Hermès  
Chaise Conservatoire  
Contour d'Hermès  
**Équilibre d'Hermès**  
Équipages d'Hermès  
Equis d'Hermès  
Hippodrome d'Hermès  
Karumi  
The Sellier Chair  
Les Nécessaires d'Hermès  
Les Trotteuses d'Hermès  
Lignage d'Hermès  
Métiers  
Oria d'Hermès  
Persiennes  
Pippa  
Jean-Michel Frank furniture  
designs by Hermès  
Sillage d'Hermès  
Sofa Sellier  
Tray-Tôt

## LIGHTING

Coulisse  
Halo  
Hécate  
Harnais  
Lanterne d'Hermès  
Pantographe  
Sarazine

# Équilibre d'Hermès

The Équilibre set by British designer Jasper Morrison exudes lightness and simplicity. On closer inspection, the shapes of these three objects prove to be more complex: a bevelled tabletop, slanted legs, crisp corners on the outside that are rounded on the inside, slatted chair backs crafted from a single piece of wood, and seats with apertures in which a saddle-stitched leather pad fits perfectly for added comfort.

Designer Jasper Morrison, English designer

# Chair and armchair Équilibre d'Hermès

## Chair and armchair

Structure in solid oak, chair back and seat in oak venner.

Seat pad in fauve saddle-stitched, creased and burnished H bull calf leather.

Designer: Jasper Morrison

Made in Denmark

- + This armchair is inspired by another Jasper Morrison design created in 1997 for the La Tourette monastery in France.
- + The chair has been redesigned, removing all straight lines and visible angles from the contours of the piece.



Chair, natural oak and fauve H bull calf, 960184M 01



Armchair, natural oak and fauve H bull calf, 960183M 01

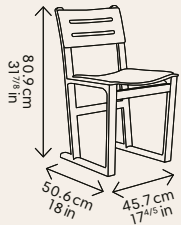

D seat base: 38.4 cm / 15<sup>1</sup>/<sub>8</sub> in  
H seat base: 47.5 cm / 18<sup>3</sup>/<sub>4</sub> in

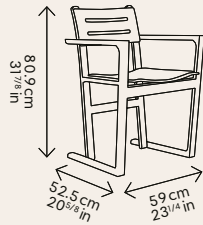

H seat base: 45.2 cm / 17<sup>13</sup>/<sub>16</sub> in  
H armrest: 66.7 cm / 26<sup>1</sup>/<sub>4</sub> in  
D seat base: 40.3 cm / 15<sup>7</sup>/<sub>16</sub> in

# Chair and armchair Équilibre d'Hermès



## References

WOOD	LEATHER	Chair	Armchair
Natural oak	Fauve H bull calf	960184M 01	960183M 01

## Important to know

Since the oil finish is manually applied, a few shiny spots may be visible on the product from certain angles.

## Care advice

- To maintain the quality of this product over time, clean regularly with a soft cloth and wipe off any stains immediately with a clean, absorbent cloth.
- For any other maintenance request, please contact Hermès Customer Service.

## Packing information

- Armchair: 1 package with a total weight of 50 kg. Package size: 73 x 67 x 116 cm (28<sup>3/4</sup> x 26<sup>3/8</sup> x 45<sup>11/16</sup> in).
- Chair: 1 package with a total weight of 47 kg. Package size: 72.5 x 67 x 112 cm (28<sup>9/16</sup> x 26<sup>3/8</sup> x 44<sup>1/16</sup> in).



# Table Équilibre d'Hermès

## Table

Solid oak

Designer: Jasper Morrison  
Made in Denmark

- + The tabletop is bevelled and the slanting legs have pointed corners on the outside but rounded corners on the inside.

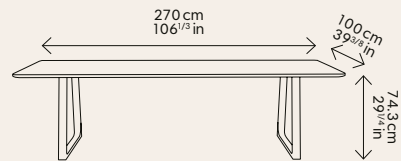
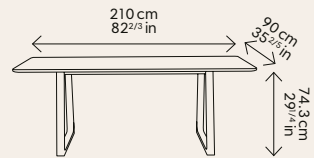

Height below the tabletop

PM: 67 cm - 26 3/8 in

GM: 67 cm - 26 3/8 in



Table PM, natural oak, 960185M 01



Table GM, natural oak, 960186M 01

# Table Équilibre d'Hermès



## References

WOOD	Table PM	Table GM
Natural oak	960185M 01	960186M 01

### Important to know

Since the oil finish is manually applied, a few shiny spots may be visible on the product from certain angles.

### Care advice

- To maintain the quality of this product over time, clean regularly with a soft cloth and wipe off any stains immediately with a clean, absorbent cloth.
- For any other maintenance request, please contact Hermès Customer Service.

### Packing information

- Small: 1 package with a total weight of 145 kg. Package size: 225 x 106 x 40 cm (88<sup>9/16</sup> x 41<sup>3/4</sup> x 15<sup>3/4</sup> in)
- Large: 1 package with a total weight of 165 kg. Package size: 285 x 111 x 40 cm (112<sup>3/16</sup> x 43<sup>11/16</sup> x 15<sup>3/4</sup> in).





## CARPETS

Cordélie

## FURNITURE

Ancelle d'Hermès  
Atout d'Hermès  
Chaise Conservatoire  
Contour d'Hermès  
Équilibre d'Hermès  
**Équipages d'Hermès**  
Equis d'Hermès  
Hippodrome d'Hermès  
Karumi  
The Sellier Chair  
Les Nécessaires d'Hermès  
Les Trotteuses d'Hermès  
Lignage d'Hermès  
Métiers  
Oria d'Hermès  
Persiennes  
Pippa  
Jean-Michel Frank furniture  
designs by Hermès  
Sillage d'Hermès  
Sofa Sellier  
Tray-Tôt

## LIGHTING

Coulisse  
Halo  
Hécate  
Harnais  
Lanterne d'Hermès  
Pantographe  
Sarazine

# Équipages d'Hermès

The Équipages d'Hermès collection is a simple concept: a use for every piece of furniture. Expertly crafted pieces as sophisticated as they are discreet, each one of these singular forms has its secret. Valet furniture in a marriage of leather and wood, wicker and copperware, these everyday essentials subtly punctuate the living space and invite all manner of reworkings.

Designer Hermès Studio

# Attelage Équipages d'Hermès

## Writing desk

Writing table in natural oak.  
Storage unit in natural oak.  
Two removable racks,  
one covered in fawn H bull calf,  
the other one in natural oak.

Designer: Hermès Studio  
Made in Italy

- + The filing cabinet slides out from under the tabletop in this modular writing desk.



Natural oak and fauve H bull calf, 960062M 01

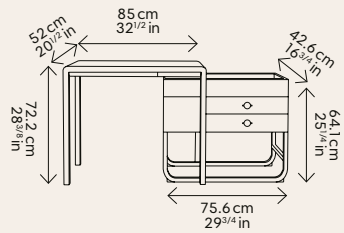

# Attelage Équipages d'Hermès



## Reference

<b>WOOD</b>	<b>LEATHER</b>	<b>Writing desk</b>
Natural oak	Fauve H bull calf	960062M 01

## Important to know

The cabinet has a compartment with a flip cover cable tray which can be used to store a lamp. Two drawers with fully leather-clad handles complete the piece.

## Care advice

When sliding the cabinet under the table, care needs to be taken to prevent damage to some of the delicate finishings. The lower drawers must be completely closed before sliding the cabinet to avoid any risk of collision.

## Packing information

1 package with a total weight of 150 kg.  
Package size: 122 x 103 x 99 cm (48 x 40<sup>2/16</sup> x 39 in).



# Diligence Équipages d'Hermès

## Serving trolley

Structure in natural maple.  
Two arches, one covered in fawn H bull calf, the other one braided with fawn H bull calf.  
Baskets in wickerwork.  
Brass trays with fawn H bull calf leather handles.  
Wheels in brass covered in fawn H bull calf leather.

Designer: Hermès Studio  
Made in Italy

+ Like a stagecoach, Diligence is intended to be used as a serving trolley or a mobile bar.



Natural maple, wicker, fauve H bull calf and brass, 960065M 01

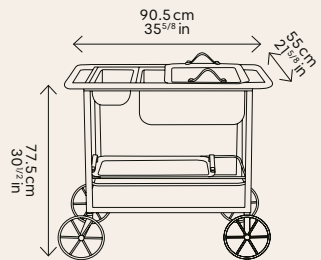

# Diligence Équipages d'Hermès



## Reference

WOOD	LEATHER	FINISH	Serving trolley
Natural maple	Fauve H bull calf	Wicker / Brass	960065M 01

## Important to know

Brass is a precious metal alloy known for its mechanical properties and its ability to acquire a patina over time.

Two types of brass are used in this product: the wheels have a permabrass finish, while the trays are made of natural brass.

## Care advice

- To maintain the shine of the brass elements, we recommend cleaning with a soft, lint-free cloth. Cleaning with a soft sponge and some soapy water is also possible.
- To prevent the appearance of water marks or scratches, use a microfibre sponge and do not leave any water on the surface.

## Packing information

1 package with a total weight of 111 kg.  
Package size: 110x72x137 cm  
(43<sup>11/16</sup> x 28<sup>3/8</sup> x 53<sup>15/16</sup> in).



# Bouchon Équipages d'Hermès

## Stool or occasional table

Structure in cork and metal, sheathed in saddle-stitched and burnished natural cowhide. Base in cork.

Designer: Hermès Studio  
Made in France

+ Small and can be easily moved  
(the large size weighs only 7 kg).



Large model, 961822M 01



Small model, 961823M 01



Large model, 960164M 01



Small model, 960148M 01

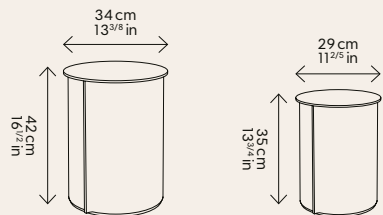

# Bouchon Équipages d'Hermès



## References

### LEATHER

Natural cowhide

Bridle leather

### Large model

960164M 01

961822M 01

### Small model

960148M 01

961823M 01

### Care advice

We recommend lifting the Bouchon off the ground when moving it so as to avoid dragging it over a rough or grainy surface.

### Packing information

1 package for small model with a total weight of 8 kg.

Orange box size: 36 x 36 x 39 cm

(14<sup>3</sup>/<sub>16</sub> x 14<sup>3</sup>/<sub>16</sub> x 15<sup>3</sup>/<sub>8</sub> in).

Package size: 42 x 42 x 46 cm

(16<sup>9</sup>/<sub>16</sub> x 16<sup>9</sup>/<sub>16</sub> x 18<sup>1</sup>/<sub>8</sub> in).

1 package for tall model with a total weight of 14.5 kg.

Orange box size: 46 x 46 x 50.5 cm

(18<sup>1</sup>/<sub>8</sub> x 18<sup>1</sup>/<sub>8</sub> x 19<sup>7</sup>/<sub>8</sub> in).

Package size: 53 x 53 x 58 cm

(20<sup>7</sup>/<sub>8</sub> x 20<sup>7</sup>/<sub>8</sub> x 22<sup>13</sup>/<sub>16</sub> in).

# Picotin Équipages d'Hermès

## Occasional table

Structure and top in natural maple.  
Basket in wickerwork.  
Lid covered in fawn H bull calf leather.

Designer: Hermès Studio  
Made in Italy

- + A picotin is a type of wicker bucket or basket used to feed animals.
- + The term is also a reference to a measure of oats used to feed a horse.
- + This name refers to the lower basket, which can be used to store a number of different accessories.



Natural maple, wicker and fauve H bull calf, 960064M 01

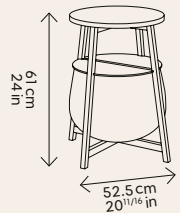

Top diameter: D 40 cm / D 15<sup>3/4</sup> in



# Picotin Équipages d'Hermès



## Reference

### WOOD

Natural maple

### FINISH

Fauve H bull calf / wicker

960064M 01

## Important to know

Wicker basket interwoven with leather along the top rim.

## Care advice

Wicker can be cleaned using a vacuum cleaner set to low, or with a damp cloth.

## Packing information

1 package with a total weight of 22 kg.  
Package size: 52 x 52 x 70 cm  
(20<sup>1/2</sup> x 20<sup>1/2</sup> x 27<sup>9/16</sup> in).

# Vice-Versa Équipages d'Hermès

## Bedside or occasional table

Structure in natural oak.  
Drawer sheathed in fauve  
H bull calf leather.  
Shelf in woven rattan cane.

Designer: Hermès Studio  
Made in Italy

- + A clever and practical design that features a two-way drawer that can be opened from both ends.



Natural oak, wicker and fauve H bull calf, 960147M 01

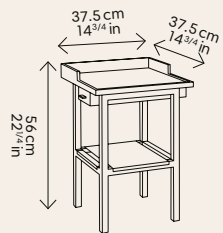

# Vice-Versa Équipages d'Hermès



## Reference

WOOD	FINISH	
Natural oak	Fauve H bull calf / Rattan	960147M 01

## Care advice

When cleaning spills or stains, ensure that the wicker shelf does not get wet. Use an absorbent cloth or a slightly damp sponge if needed, then pat-dry the area immediately using a soft cotton cloth.

## Packing information

1 package with a total weight of 34 kg.  
Orange box size: 46.5 x 46,5 x 59.5 cm  
(18<sup>5/16</sup> x 18<sup>5/16</sup> x 23<sup>7/16</sup> in).

Size of the package: 62 x 55 x 69 cm  
(24<sup>7/16</sup> x 21<sup>5/8</sup> x 27<sup>3/16</sup> in).



## CARPETS

Cordélie

## FURNITURE

Ancelle d'Hermès

Atout d'Hermès

Chaise Conservatoire

Contour d'Hermès

Équilibre d'Hermès

Équipages d'Hermès

**Equis d'Hermès**

Hippodrome d'Hermès

Karumi

The Sellier Chair

Les Nécessaires d'Hermès

Les Trotteuses d'Hermès

Lignage d'Hermès

Métiers

Oria d'Hermès

Persiennes

Pippa

Jean-Michel Frank furniture

designs by Hermès

Sillage d'Hermès

Sofa Sellier

Tray-Tôt

## LIGHTING

Coulisse

Halo

Hécate

Harnais

Lanterne d'Hermès

Pantographe

Sarazine

# Equis d'Hermès

Sleek, compact design and sophisticated assembly are the signatures of the Equis d'Hermès collection by Rafael Moneo. Ethereal and architectural, the chair and table originally designed in 1961 were not manufactured for the first time until 2016. The tabletop and legs are attached with wooden corner braces, while brushed brass rods structure the piece. The seat and back of the chairs are covered with hand-stitched leather borrowing from Hermès saddlery expertise. Equis means "X" in Spanish, a nod to the origins of the designer as well as the metal structure of the seat and the equestrian world of Hermès.

Designer Rafael Moneo, Spanish architect

# Chair and table Equis d'Hermès

## Chair

Legs in solid oak.  
Seat and back covered  
in natural cowhide.  
Metal stays in steel with  
brushed gold finish.

## Table

Legs in solid oak.  
Top in oak veneer.  
Bracket details in laminated wood.  
Metal stays in steel  
with brushed gold finish.

Designer: Rafael Moneo  
Made in France

- + The top of the chair's seat back is designed to be at the exact same height as the Equis d'Hermès tabletop.

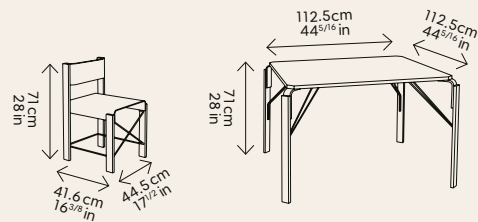

D seat base: 39.1 cm / 15 3/8 in  
H seat base: 43 cm / 16 7/8 in  
height under table: 69 cm / 27 3/16

**Chair**, natural oak, natural cowhide, steel with brushed gold finish, 960039M 01

**Table**, natural oak, steel with brushed gold finish, 960040M 01

# Chair and table Equis d'Hermès



## References

WOOD	LEATHER	FINISH	Chair	Table
Natural oak	Natural cowhide	Steel with brushed gold	960039M 01	960040M 01

### Important to know

For the chair: the leather cladding of the seat and the back as well as the polishing of the edges take a total of 18 hours of work

### Care advice

- To maintain the quality of this product over time, clean regularly with a soft cloth and wipe off any stains immediately with a clean, absorbent cloth.
- For any other maintenance request, please contact Hermès Customer Service.

### Packing information

- Chair: 1 package with a total weight of 12.5 kg. Package size: 57 x 60 x 96 cm (22<sup>7/16</sup> x 23<sup>5/8</sup> x 37<sup>13/16</sup> in).
- Table: 1 package with a total weight of 98 kg. Package size: 130 x 130 x 95 cm (51<sup>3/16</sup> x 51<sup>3/16</sup> x 37<sup>3/8</sup> in).

## CARPETS

Cordélie

## FURNITURE

Ancelle d'Hermès  
Atout d'Hermès  
Chaise Conservatoire  
Contour d'Hermès  
Équilibre d'Hermès  
Équipages d'Hermès  
Equis d'Hermès  
**Hippodrome d'Hermès**  
Karumi  
The Sellier Chair  
Les Nécessaires d'Hermès  
Les Trotteuses d'Hermès  
Lignage d'Hermès  
Métiers  
Oria d'Hermès  
Persiennes  
Pippa  
Jean-Michel Frank furniture  
designs by Hermès  
Sillage d'Hermès  
Sofa Sellier  
Tray-Tôt

## LIGHTING

Coulisse  
Halo  
Hécate  
Harnais  
Lanterne d'Hermès  
Pantographe  
Sarazine

# Hippodrome d'Hermès

The Hippodrome d'Hermès coffee table by French design duo Normal Studio combines a rectangular tabletop in oiled oak featuring aircraft wing edges and an oval lower shelf covered in smoothed and burnished bridle leather. A large, structured piece, made lighter by slender legs set back from the edges.

Designer Normal Studio, French designers

# Coffee table Hippodrome d'Hermès

## Coffee table

Legs in solid oak or Canaletto walnut.

Tabletop and shelf in oiled oak or Canaletto walnut veneer.

Shelf covered in creased and burnished bridle leather.

Designer: Normal Studio

Made in Italy

- + The tabletop is slightly concave and features air-plane wing edges.
- + The legs are unexpectedly positioned at the middle of the sides so that the lower shelf can be accessed easily.



Oak and brique bridle leather, 960165M 01



Canaletto walnut and moka bridle leather, 960166M 01

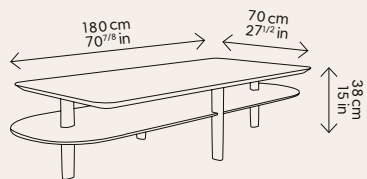



# Coffee table Hippodrome d'Hermès



## Reference

WOOD	LEATHER	Coffee table
Natural oak	Bridle leather, natural	960165M 01
Canaletto walnut	Bridle leather, moka	960166M 01

## Care advice

- To maintain the quality of this product over time, clean regularly with a soft cloth and wipe off any stains immediately with a clean, absorbent cloth.
- For any other maintenance request, please contact Hermès Customer Service.

## Packing information

1 package with a total weight of 136 kg.  
Package size: 202 x 89 x 62 cm  
(79<sup>1/2</sup> x 35<sup>1/16</sup> x 24<sup>7/16</sup> in).

## CARPETS

Cordélie

## FURNITURE

Ancelle d'Hermès

Atout d'Hermès

Chaise Conservatoire

Contour d'Hermès

Équilibre d'Hermès

Équipages d'Hermès

Equis d'Hermès

Hippodrome d'Hermès

### Karumi

The Sellier Chair

Les Nécessaires d'Hermès

Les Trotteuses d'Hermès

Lignage d'Hermès

Métiers

Oria d'Hermès

Persiennes

Pippa

Jean-Michel Frank furniture

designs by Hermès

Sillage d'Hermès

Sofa Sellier

Tray-Tôt

## LIGHTING

Coulisse

Halo

Hécate

Harnais

Lanterne d'Hermès

Pantographe

Sarazine

# Karumi

These three seats lay down a challenge for the material. Japanese master craftsmen fashion a heart of carbon fiber for the bamboo bench frame. Tradition meets high tech in this innovative piece that showcases bamboo in a clean, uncluttered design. Karumi is Japanese for "lightness through simplicity". Far from a showy technique and gratuitous form, Portuguese architect Alvaro Siza Vieira delivers here pieces of a modest yet complex architecture inspired by artisanal techniques.

Designer Alvaro Siza, Portuguese architect

# Triangular and square stools Karumi

## Triangular and square stools

Bamboo.  
Removable cushion in fawn  
H bull calf leather.

Designer: Alvaro Siza  
Made in Japan

+ In Japanese, Karumi is a term originating in Buddhist philosophy to refer to a state of "lightness", but which also more broadly conveys a quest for "lightness through simplicity".



Triangular stool, bamboo, 960070M 01



Square stool, bamboo, 960069M 01  
Optional fauve H bull calf leather pad, 960074M 01

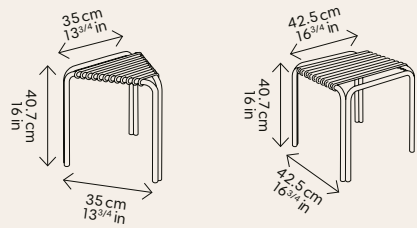

# Triangular and square stools Karumi



## References

WOOD	LEATHER	Triangular stool	Square stool	Cushion for square stool
Bamboo	Fauve H bull calf	960070M 01	960069M 01	960074M 01

### Important to know

Bamboo is renowned for its solidity and durability while also being a flexible and very lightweight material.

### Care advice

- To maintain the quality of this product over time, clean regularly with a soft cloth and wipe off any stains immediately with a clean, absorbent cloth.
- For any other maintenance request, please contact Hermès Customer Service.

### Packing information

- Triangular stool: 1 package with a total weight of 14 kg. Package size: 52 x 52 x 38 cm (20<sup>1/2</sup> x 20<sup>1/2</sup> x 14<sup>15/16</sup> in).
- Square stool: 1 package with a total weight of 17.5 kg. Package size: 52 x 49 x 70 cm (20<sup>1/2</sup> x 19<sup>5/16</sup> x 27<sup>9/16</sup> in).



# Bench Karumi

## Bench

Structure in bamboo with carbon fibre core.  
Two removable cushions in fawn H bull calf leather.

Designer: Alvaro Siza  
Made in Japan

- + In Japanese, Karumi is a term originating in Buddhist philosophy to refer to a state of "lightness", but which also more broadly conveys a quest for "lightness through simplicity".



**Bench**, bamboo, 960071M 01  
Optional fauve H bull calf leather pad, 960075M 01

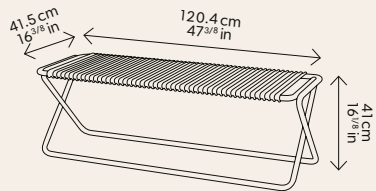

# Bench Karumi



## References

WOOD	LEATHER	Bench	Cushion for bench
Bamboo	Fauve H bull calf	960071M 01	960075M 01

## Important to know

The simplicity of line and light construction of this piece hide an invisible complexity, with its laminated bamboo frame held together by an inner heart of carbon fibre.

## Care advice

- To maintain the quality of this product over time, clean regularly with a soft cloth and wipe off any stains immediately with a clean, absorbent cloth.
- For any other maintenance request, please contact Hermès Customer Service.

## Packing information

1 package with a total weight of 24 kg.  
Package size: 127 x 51 x 60 cm  
(50 x 20<sup>1/16</sup> x 23<sup>5/8</sup> in).



## CARPETS

Cordélie

## FURNITURE

Ancelle d'Hermès

Atout d'Hermès

Chaise Conservatoire

Contour d'Hermès

Équilibre d'Hermès

Équipages d'Hermès

Equis d'Hermès

Hippodrome d'Hermès

Karumi

**The Sellier Chair**

Les Nécessaires d'Hermès

Les Trotteuses d'Hermès

Lignage d'Hermès

Métiers

Oria d'Hermès

Persiennes

Pippa

Jean-Michel Frank furniture

designs by Hermès

Sillage d'Hermès

Sofa Sellier

Tray-Tôt

## LIGHTING

Coulisse

Halo

Hécate

Harnais

Lanterne d'Hermès

Pantographe

Sarazine

# The Sellier Chair

Fully covered with leather in neutral tones or bright colours, The Sellier Chair is at home in any room.

Designers Denis Montel (RDAI), French architect and Eric Benqué, French designer

# Chair The Sellier Chair

## Chair

Structure, legs and armrests covered in Everlisse bull calf leather.  
Removable cover with zip fastening.

Designer: Denis Montel (RDAI) & Éric Benqué  
Made in Italy

- + The iconic saddle-making expertise of Hermès is visible in this chair, with its saddle-stitch finish in a contrasting lighter colour and the burnished finish.



Chair without armrests, black Everlisse bull calf leather, 960298M 06



Chair with armrests, rouge H Everlisse bull calf leather, 960297M 09

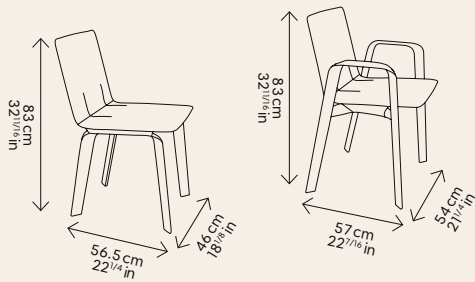

Seat depth: 42 cm / 16<sup>1</sup>/<sub>2</sub> in  
Seat height: 48 cm / 18<sup>7</sup>/<sub>8</sub> in

Seat depth: 42 cm / 16<sup>1</sup>/<sub>2</sub> in  
Seat height: 48 cm / 18<sup>7</sup>/<sub>8</sub> in  
Armrests height: 65 cm / 25<sup>5</sup>/<sub>8</sub> in



# Chair The Sellier Chair



Everlisse bull calf leather bleu marine



Everlisse bull calf leather vert forêt

## Finishes

### Everlisse bull calf leather

gris perle

étoupe

gold

étain

noir

brique

rouge H

bleu marine

vert forêt

# Chair The Sellier Chair



## References

LEATHER	FINISH	WITHOUT ARMRESTS		WITH ARMRESTS	
		Worldwide except USA	USA	Worldwide except USA	USA
Everlisse bull calf leather	Everlisse bull calf leather / gris perle	960298MW01	960298MU01	960297MW01	960297MU01
	Everlisse bull calf leather / étoupe	960298MW03	960298MU03	960297MW03	960297MU03
	Everlisse bull calf leather / gold	960298MW04	960298MU04	960297MW04	960297MU04
	Everlisse bull calf leather / étain	960298MW05	960298MU05	960297MW05	960297MU05
	Everlisse bull calf leather / noir	960298MW06	960298MU06	960297MW06	960297MU06
	Everlisse bull calf leather / brique	960298MW07	960298MU07	960297MW07	960297MU07
	Everlisse bull calf leather / rouge H	960298MW09	960298MU09	960297MW09	960297MU09
	Everlisse bull calf leather / bleu marine	960298MW19	960298MU19	960297MW19	960297MU19
	Everlisse bull calf leather / vert foret	960298MW20	960298MU20	960297MW20	960297MU20

### Important to know

Available in many colours, ranging from the understated to the unexpected.

### Care advice

- To maintain the quality of this product over time, clean regularly with a soft cloth and wipe off any stains immediately with a clean, absorbent cloth.
- For any other maintenance request, please contact Hermès Customer Service.

### Packing information

- Chair without armrest: 1 package with a total weight of 46 kg. Package size: 62 x 75 x 106 cm (24<sup>7/16</sup> x 29<sup>1/2</sup> x 41<sup>3/4</sup> in).
- Chair with armrest: 1 package with a total weight of 51 kg. Package size: 71 x 70 x 106 cm (27<sup>15/16</sup> x 27<sup>9/16</sup> x 41<sup>3/4</sup> in).

## CARPETS

Cordélie

## FURNITURE

Ancelle d'Hermès

Atout d'Hermès

Chaise Conservatoire

Contour d'Hermès

Équilibre d'Hermès

Équipages d'Hermès

Equis d'Hermès

Hippodrome d'Hermès

Karumi

The Sellier Chair

**Les Nécessaires d'Hermès**

Les Trotteuses d'Hermès

Lignage d'Hermès

Métiers

Oria d'Hermès

Persiennes

Pippa

Jean-Michel Frank furniture

designs by Hermès

Sillage d'Hermès

Sofa Sellier

Tray-Tôt

## LIGHTING

Coulisse

Halo

Hécate

Harnais

Lanterne d'Hermès

Pantographe

Sarazine

# Les Nécessaires d'Hermès

Les Nécessaires d'Hermès is a collection of useful and comfortable everyday furniture with many different purposes, created by the French designer Philippe Nigro. Les Nécessaires d'Hermès collection has been crafted in the high quality tradition of cabinet-making and upholstery, along with expertise in the noblest materials: solid oak, Canaletto walnut and H bull calf leather.

Designer Philippe Nigro, French designer

# Coffre à lutrin Les Nécessaires d'Hermès

## A mobile work station, occasional bookstand and storage chest

Three-part design in Canaletto walnut or oak on wheels.

Exterior upholstered in H bull calf leather and Cravache fabric.

Interior and storage in H bull calf leather and Canaletto walnut or oak.

Adjustable bookstand, pull-tabs in Canaletto walnut or oak and handles upholstered in H bull calf leather.

Leather clasp with metallic hinge plate.

Designer: Philippe Nigro

Made in France

- + Ingenious accent piece combining rigour and novelty.
- + This multi-purpose cabinet features a fold-out desktop and retractable pulls, drawers, a magazine rack, a removable pouch and a secret compartment.

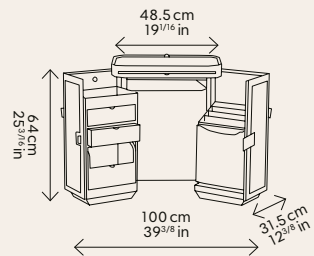

Open  
L 100 x I 31.5 x H 64 cm  
39 3/8 x 12 3/8 x 25 1/16 in

Closed  
L 48.5 x I 31.5 x H 64 cm  
19 1/16 x 12 3/8 x 25 1/16 in



Open chest, Canaletto walnut, fauve H bull calf leather and seigle Cravache fabric, 960140M 01



Closed chest, Canaletto walnut, fauve H bull calf leather and seigle Cravache fabric, 960140M 01

# Coffre à lutrin Les Nécessaires d'Hermès



**Natural oak**, chocolat H bull calf leather and étoupe clair Cravache fabric



**Canaletto walnut**, fauve H bull calf leather and seigle Cravache fabric

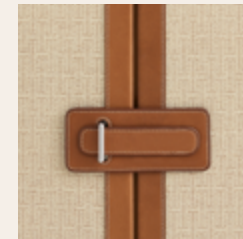

## Finishes

**Oak**

**H bull calf leather / Cravache**

fauve / seigle

chocolat / étoupe clair

**Canaletto walnut**

**H bull calf leather / Cravache**

fauve / seigle

chocolat / étoupe clair

# Coffre à lutrin Les Nécessaires d'Hermès



## References

WOOD	FINISH	
Natural oak	H bull calf leather fauve / Cravache seigle	931087M 01
	H bull calf leather chocolat / Cravache étoupe clair	931087M 02
Canaletto walnut	H bull calf leather fauve / Cravache seigle	960140M 01
	H bull calf leather chocolat / Cravache étoupe clair	960140M 02

## Care advice

- To maintain the quality of this product over time, clean regularly with a soft cloth and wipe off any stains immediately with a clean, absorbent cloth.
- For any other maintenance request, please contact Hermès Customer Service.

## Packing information

1 package with a total weight of 46 kg.  
Package size: 59 x 46 x 87 cm  
(23<sup>1/4</sup> x 18<sup>1/8</sup> x 34<sup>1/4</sup> in).

# Ottoman Les Nécessaires d'Hermès

## Additional mobile seating, foot rest, storage

Two-part structure.  
Storage chest upholstered in H bull calf leather and Toile H Décoration with leather handle.  
Cover upholstered in H bull calf.  
Leather, interior lined in Toile H Décoration.

Designer: Philippe Nigro  
Made in France

- + This equestrian-inspired design recalls the shape of a saddle.
- + This small accent piece of occasional furniture can be used to store throws, magazines or other small objects.



Fauve H bull calf leather, interior in Toile H Décoration fabric, 960407M 01

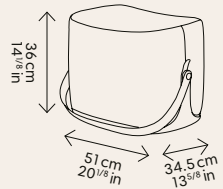

## Finishes

### H bull calf leather / Toile H

fauve / cannelle

noir ébène / ébène

chocolat / ébène

# Ottoman Les Nécessaires d'Hermès

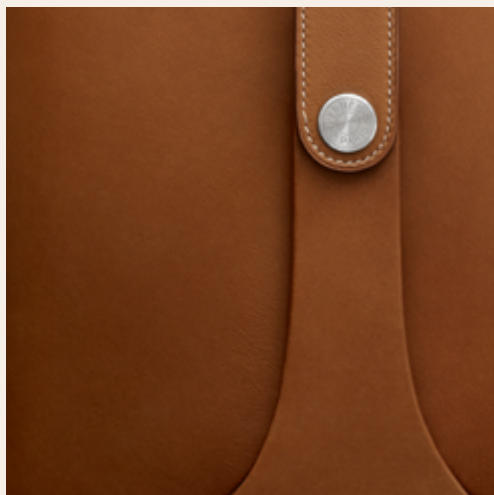

## References

LEATHER	FINISH	Worldwide except USA	USA
	H bull calf leather fauve / Toile H cannelle	960407MW01	960407MU01
H bull calf leather	H bull calf leather noir ébène / Toile H ébène	960407MW03	960407MU03
	H bull calf leather chocolat / Toile H ébène	960407MW04	960407MU04

## Important to know

- The thin protective pigment layer applied to the leather preserves the natural look of the material. The grain, pores and other aspects of the hide remain visible.

## Care advice

- To maintain the quality of this product over time, clean regularly with a soft cloth and wipe off any stains immediately with a clean, absorbent cloth.
- For any other maintenance request, please contact Hermès Customer Service.

## Packing information

1 package with a total weight of 28 kg.  
Package size: 68 x 52 x 58 cm  
(26<sup>3/4</sup> x 20<sup>1/2</sup> x 22<sup>13/16</sup> in).



# Vestiaire Les Nécessaires d'Hermès

## Coat rack and accessory holder

Folding structure in solid Canaletto walnut or solid oak.  
Hooks and feet in brushed stainless steel.  
Two small accessory shelves and bag shelf in wood covered in H bull calf leather.

Designer: Philippe Nigro  
Made in France

- + Four hidden hooks at different levels of the structure.

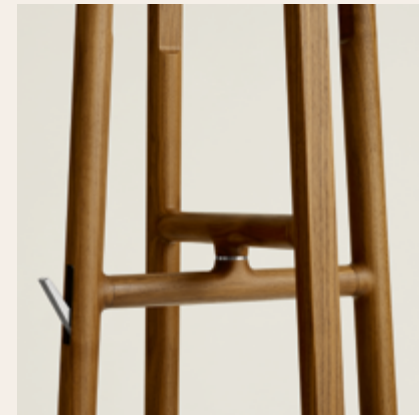
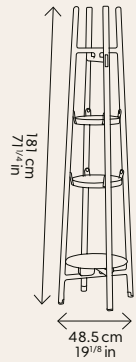

Canaletto walnut version, chocolat H bull calf leather, 960125M 04

# Vestiaire Les Nécessaires d'Hermès



Natural oak, fauve H bull calf leather,  
931089M 01



Canaletto walnut, chocolat H bull calf leather,  
960125M 04



Ebonised walnut, rouge H H bull calf leather,  
960189M 01

## Finishes

Oak

Canaletto walnut

Ebonised walnut

H bull calf leather

H bull calf leather

H bull calf leather

fauve

chocolat

fauve

chocolat

noir ébène

rouge H

# Vestiaire Les Nécessaires d'Hermès



## References

WOOD	FINISH	
Natural oak	H bull calf leather fauve	931089M 01
	H bull calf leather chocolat	931089M 02
Canaletto walnut	H bull calf leather fauve	960125M 01
	H bull calf leather noir ébène	960125M 03
Ebonised walnut	H bull calf leather chocolat	960125M 04
	H bull calf leather rouge H	960189M 01

## Care advice

- To maintain the quality of this product over time, clean regularly with a soft cloth and wipe off any stains immediately with a clean, absorbent cloth.
- For any other maintenance request, please contact Hermès Customer Service.

## Packing information

1 package with a total weight of 47 kg.  
Package size: 192 x 64 x 49 cm  
(75<sup>3/16</sup> x 25<sup>3/16</sup> x 19<sup>5/16</sup> in).

# Groom Les Nécessaires d'Hermès

## A faithful servant

Metallic structure in solid Canaletto walnut or solid oak with brushed stainless-steel feet. Pivoting mirror, leather-covered back (H bull calf) with coat peg and pocket. Hooks in brushed stainless steel. Four leather-covered trouser racks without pivoting. Accessories shelf in brushed stainless steel or covered in H bull calf leather, jewellery compartment in wood oak. Bag rest covered in H bull calf leather.

Designer: Philippe Nigro  
Made in France

- + In the equestrian world, someone who assists the horse rider while in competition is called a groom.
- + Grooms are responsible for racehorses, travelling with their employers to provide support services and care for the animals during competition.

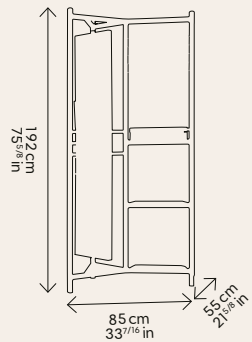

Natural oak version, fauve H bull calf leather, 931088M 01

# Groom Les Nécessaires d'Hermès



Natural oak, fauve H bull calf leather



Canaletto walnut, chocolat H bull calf leather



Ebonised walnut, rouge H H bull calf leather

## Finishes

Oak

Canaletto walnut

Ebonised walnut

H bull calf leather

H bull calf leather

H bull calf leather

fauve

chocolat

fauve

chocolat

noir ébène

rouge H

# Groom Les Nécessaires d'Hermès



## References

WOOD	FINISH	
Natural oak	H bull calf leather fauve	931088M 01
	H bull calf leather chocolat	931088M 02
Canaletto walnut	H bull calf leather fauve	960139M 01
	H bull calf leather noir ébène	960139M 03
Ebonised walnut	H bull calf leather chocolat	960139M 04
	H bull calf leather rouge H	960188M 01

## Care advice

- To maintain the quality of this product over time, clean regularly with a soft cloth and wipe off any stains immediately with a clean, absorbent cloth.
- For any other maintenance request, please contact Hermès Customer Service.

## Packing information

1 package with a total weight of 112 kg.  
Package size: 110 x 65 x 210 cm  
(43<sup>5/16</sup> x 25<sup>9/16</sup> x 82<sup>11/16</sup> in).  
Consult the video for specific instructions on how to unpack and install Groom.  
Request Métiers to provide the video.

# Cabriolet Les Nécessaires d'Hermès

## Compact seat

Legs in solid Canaletto walnut or solid oak with brushed stainless-steel feet.

Hull upholstered in H bull calf leather, padded seat and back upholstered in leather or in leather and fabric.

Designer: Philippe Nigro  
Made in Italy

- + This piece is inspired by the equestrian world. The cabriolet was a two-wheeled carriage seating up to 2 or 3 people. It was the first horse-drawn "taxi" coach (1790).
- + The curved back rest mirrors the shape of the back.

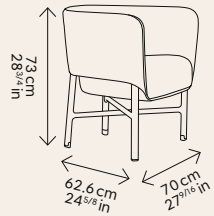

D seat base: 46 cm / 18<sup>1</sup>/<sub>8</sub> in  
H seat base: 44.2 cm / 17<sup>3</sup>/<sub>8</sub> in  
H armrest: 73 cm / 28<sup>3</sup>/<sub>4</sub> in



All-leather version, oak, chocolat H bull calf leather, 960398M 02



Leather and fabric version, oak, hull upholstered in fauve H bull calf leather, padded seat and back in seigle Cravache fabric, 9960256M 01

# Cabriolet Les Nécessaires d'Hermès



Canaletto walnut, fauve H bull calf leather



Oak, fauve H bull calf leather, seigle Cravache fabric



Canaletto walnut, chocolat H bull calf leather and étoupe Cheval Pixel fabric

## Finishes

### Oak

#### H bull calf leather

fauve                      chocolat

#### H bull calf leather / Cravache

fauve / seigle

### Canaletto walnut

#### H bull calf leather

fauve                      chocolat                      noir ébène

#### H bull calf leather / Cravache

fauve / seigle

#### H bull calf leather / Cheval Pixel

chocolat / étoupe                      noir ébène/noir et blanc



# Cabriolet Les Nécessaires d'Hermès

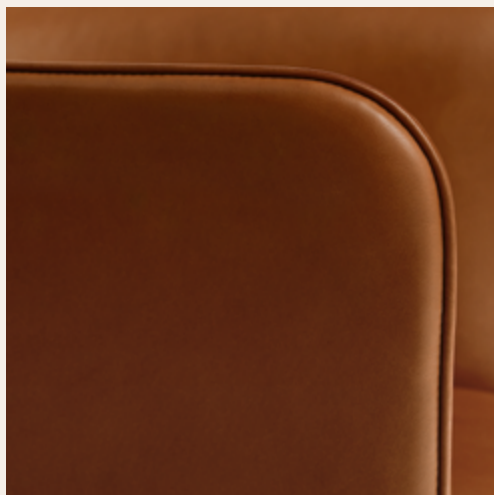

## References

WOOD	FINISH	Worldwide except USA / UK / HK / Chine	USA	UK / HK / Chine
Natural oak	H bull calf leather fauve	960398MW01	960398MU01	960398MW01
	H bull calf leather chocolat	960398MW02	960398MU02	960398MW02
	H bull calf leather fauve / Cravache seigle	960256MW01	961851MU01	961851MG01
Canaletto walnut	H bull calf leather fauve	960397MW01	960397MU01	960397MW01
	H bull calf leather noir ébène	960397MW03	960397MU03	960397MW03
	H bull calf leather chocolat	960397MW04	960397MU04	960397MW04
	H bull calf leather fauve / Cravache seigle	960355MW01	961854MU01	961854MG01
	H bull calf leather noir ébène / Cheval Pixel noir et blanc	960356MW02	*	*
	H bull calf leather chocolat / Cheval Pixel étoupe	960356MW03	*	*

\* Temporarily unavailable for importation.

### Important to know

- Leather piping skilfully enhances the shape of the armchair.
- Resin shell with injected foam padding.

### Care advice

- To maintain the quality of this product over time, clean regularly with a soft cloth and wipe off any stains immediately with a clean, absorbent cloth.
- For any other maintenance request, please contact Hermès Customer Service.

### Packing information

1 package with a total weight of 60 kg.  
 Package size: 90 x 84 x 100 cm  
 (35<sup>7/16</sup> x 33<sup>1/16</sup> x 39<sup>3/8</sup> in).

# Carré d'assise Les Nécessaires d'Hermès

## A convenient low stool, an occasional table

Structure in wood and legs in solid Canaletto walnut or solid oak with brushed stainless-steel feet. Firmly padded seat. Cover in H bull calf leather, sheepskin or leather and fabric.

Designer: Philippe Nigro  
Made in France

- + These stools recall the shape of Hermès silk scarves.
- + Different sizes, heights and cushion finishes can be mixed and matched to create unique combinations.



Carré d'assise 65 medium model, leather and fabric version, solid oak, fauve H bull calf, 960486M 01



Carré d'assise 65 high model, all-leather version, Canaletto walnut, fauve H bull calf, 960383M 01

## Carré d'assise 65

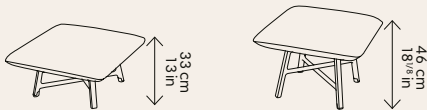

## Carré d'assise 85



Carré d'assise 85 medium model, all-leather version, Canaletto walnut, fauve H bull calf, 960391M 01



Carré d'assise 85 high model, leather and fabric version, solid oak, fauve H bull calf, 960474M 01

# Carré d'assise Les Nécessaires d'Hermès



Canaletto walnut, fauve H bull calf



Oak, fauve H bull calf et Cadre fabric



Canaletto walnut, chocolat H bull calf and Entrelacs fabric



Canaletto walnut, chocolat H bull calf and Echelle fabric

## Finishes

**Oak**

**H bull calf leather**

fauve      chocolat

**Canaletto walnut**

**H bull calf leather**

fauve      chocolat

noir ébène

**H bull calf / Cadre**

fauve

**H bull calf / Entrelacs**

fauve

**H bull calf / Entrelacs**

chocolat

**H bull calf / Echelle**

fauve

**H bull calf / Echelle**

chocolat

# Carré d'assise Les Nécessaires d'Hermès



Oak, fauve H bull calf and sheepskin



Canaletto walnut, chocolat H bull calf and étoupe Cheval Pixel fabric



Canaletto walnut, fauve H bull calf and seigle Cravache fabric



Canaletto walnut, noir ébène H bull calf and ébène Toile H fabric

## Finishes

### Oak

H bull calf leather / Sheepskin

fauve / Sheepskin

### Canaletto walnut

H bull calf leather / Sheepskin

fauve / Sheepskin

H bull calf leather / Cheval Pixel

chocolat / étoupe    noir ébène / noir et blanc

H bull calf leather / Cravache

fauve / seigle

H bull calf leather / Cravache

fauve / seigle

H bull calf leather / Toile H

fauve / cannelle

H bull calf leather / Toile H

fauve / cannelle    chocolat / ébène    noir ébène / ébène

**Important to know:** the finishes in sheepskin, Cheval Pixel, Cravache and Toile H are embellished with leather corner pieces.

# Carré d'assise Les Nécessaires d'Hermès





## Care advice

- Hermès recommends getting the fabrics professionally cleaned. For regular maintenance, lightly dust or brush the fabric with a feather duster or a soft brush.
- Spills and stains must be immediately wiped using a clean, absorbent cloth.

## Packing information

- Carré 65 medium model:  
1 package with a total weight of 44 kg.  
Package size: 87 x 87 x 61 cm.  
(34<sup>1/4</sup> x 34<sup>1/4</sup> x 24 in)
- Carré 65 high model:  
1 package with a total weight of 47 kg.  
Package size: 87 x 87 x 73 cm.  
(34<sup>1/4</sup> x 34<sup>1/4</sup> x 28<sup>3/4</sup> in).

## References

WOOD	FINISH	CARRÉ 65 MEDIUM MODEL 			CARRÉ 65 HIGH MODEL 		
		Worldwide except USA / UK / HK / Chine	USA	UK / HK / Chine	Worldwide except USA / UK / HK / Chine	USA	UK / HK / Chine
Natural oak	H bull calf leather fauve	960386MW01	960386MU01	960386MW01	960384MW01	960384MU01	960384MW01
	H bull calf leather chocolat	960386MW02	960386MU02	960386MW02	960384MW02	960384MU02	960384MW02
	H bull calf leather fauve / Sheepskin	960292MW01	960292MU01	960292MW01	960287MW01	960287MU01	960287MW01
	H bull calf leather fauve / Toile H cannelle	960293MW01	961841MU01	961841MG01	960288MW01	961839MU01	961839MG01
	H bull calf leather fauve / Cravache seigle	960294MW01	961842MU01	961842MG01	960289MW01	961840MU01	961840MG01
	H bull calf leather fauve / Cadre	960480MW01	960480MU01	960480MW01	960481MW01	960481MU01	960481MW01
	H bull calf leather fauve / Entrelacs	960482MW01	960482MU01	960482MW01	960484MW01	960484MU01	960484MW01
	H bull calf leather fauve / Echelle	960486MW01	960486MU01	960486MW01	960488MW01	960488MU01	960488MW01
	H bull calf leather fauve	960385MW01	960385MU01	960385MW01	960383MW01	960383MU01	960383MW01
	H bull calf leather noir ébène	960385MW03	960385MU03	960385MW03	960383MW03	960383MU03	960383MW03
Canaletto walnut	H bull calf leather chocolat	960385MW04	960385MU04	960385MW04	960383MW04	960383MU04	960383MW04
	H bull calf leather fauve / Sheepskin	960350MW01	960350MU01	960350MW01	960346MW01	960346MU01	960346MW01
	H bull calf leather fauve / Toile H cannelle	960352MW01	961850MU01	961850MG01	960348MW01	961848MU01	961848MG01
	H bull calf leather noir ébène / Toile H ébène	960352MW02	961850MU02	961850MG02	960348MW02	961848MU02	961848MG02
	H bull calf leather chocolat / Toile H ébène	960352MW03	961850MU03	961850MG03	960348MW03	961848MU03	961848MG03
	H bull calf leather fauve / Cravache seigle	960351MW01	961849MU01	961849MG01	960347MW01	961847MU01	961847MG01
	H bull calf leather noir ébène / Cheval Pixel noir et blanc	960353MW02	*	*	960349MW02	*	*
	H bull calf leather chocolat / Cheval Pixel étoupe	960353MW03	*	*	960349MW03	*	*
H bull calf leather chocolat / Entrelacs	960483MW01	960483MU01	960483MW01	960485MW01	960485MU01	960485MW01	
H bull calf leather chocolat / Echelle	960487MW01	960487MU01	960487MW01	960489MW01	960489MU01	960489MW01	

\*Temporarily unavailable for importation.

# Carré d'assise Les Nécessaires d'Hermès





## Important to know

The finishes in sheepskin, Cheval Pixel, Cravache and Toile H are embellished with leather corner pieces.

## Packing information

- Carré 85 medium model:  
1 package with a total weight of 55 kg.  
Package size: 101 x 101 x 55 cm. (39<sup>3/4</sup> x 39<sup>3/4</sup> x 21<sup>5/8</sup> in).
- Carré 85 high model: 1 package with a total weight of 57 kg.  
Package size: 101 x 101 x 69 cm. (39<sup>3/4</sup> x 39<sup>3/4</sup> x 27<sup>3/16</sup> in).
- Carré 65 medium model:  
1 package with a total weight of 36 kg.  
Package size: 87 x 87 x 61 cm. (34<sup>1/4</sup> x 34<sup>1/4</sup> x 24 in).
- Carré 65 high model: 1 package with a total weight of 47 kg.  
Package size: 87 x 87 x 73 cm. (34<sup>1/4</sup> x 34<sup>1/4</sup> x 28<sup>3/4</sup> in).

## References

WOOD	FINISH	CARRÉ 85 MEDIUM MODEL 			CARRÉ 85 HIGH MODEL 		
		Worldwide except USA / UK / HK / Chine	USA	UK / HK / Chine	Worldwide except USA / UK / HK / Chine	USA	UK / HK / Chine
Natural oak	H bull calf leather fauve	960392MW01	960392MU01	960392MW01	960390MW01	960390MU01	960390MW01
	H bull calf leather chocolat	960392MW02	960392MU02	960392MW02	960390MW02	960390MU02	960390MW02
	H bull calf leather fauve / Sheepskin	960277MW01	960277MU01	960277MW01	960272MW01	960272MU01	960272MW01
	H bull calf leather fauve / Toile H cannelle	960278MW01	961837MU01	961837MG01	960273MW01	961835MU01	961835MG01
	H bull calf leather fauve / Cravache seigle	960279MW01	961838MU01	961838MG01	960274MW01	961836MU01	961836MG01
	H bull calf leather fauve / Cadre	960470MW01	960470MU01	960470MW01	960471MW01	960471MU01	960471MW01
Canaletto walnut	H bull calf leather fauve / Entrelacs	960472MW01	960472MU01	960472MW01	960474MW01	960474MU01	960474MW01
	H bull calf leather fauve / Echelle	960476MW01	960476MU01	960476MW01	960478MW01	960478MU01	960478MW01
	H bull calf leather fauve	960391MW01	960391MU01	960391MW01	960389MW01	960389MU01	960389MW01
	H bull calf leather noir ébène	960391MW03	960391MU03	960391MW03	960389MW03	960389MU03	960389MW03
	H bull calf leather chocolat	960391MW04	960391MU04	960391MW04	960389MW04	960389MU04	960389MW04
	H bull calf leather fauve / Sheepskin	960338MW01	960338MU01	960338MW01	960334MW01	960334MU01	960334MW01
	H bull calf leather fauve / Toile H cannelle	960340MW01	961846MU01	961846MG01	960336MW01	961844MU01	961844MG01
	H bull calf leather noir ébène / Toile H ébène	960340MW02	961846MU02	961846MG02	960336MW02	961844MU02	961844MG02
	H bull calf leather chocolat / Toile H ébène	960340MW03	961846MU03	961846MG03	960336MW03	961844MU03	961844MG03
	H bull calf leather fauve / Cravache seigle	960339MW01	961845MU01	961845MG01	960335MW02	961843MU01	961843MG01
H bull calf leather noir ébène / Cheval Pixel noir et blanc	960341MW02	*	*	960337MW02	*	*	
H bull calf leather chocolat / Cheval Pixel étoupe	960341MW03	*	*	960337MW03	*	*	
H bull calf leather chocolat / Entrelacs	960473MW01	960473MU01	960473MW01	960475MW01	960475MU01	960475MW01	
H bull calf leather chocolat / Echelle	960477MW01	960477MU01	960477MW01	960479MW01	960479MU01	960479MW01	

\* Temporarily unavailable for importation.

# Cheval d'arçons Les Nécessaires d'Hermès

## Bench with drawers, an additional surface

Structure in wood. Legs,  
drawers and casing in solid  
Canaletto walnut or solid oak.  
Feet in brushed stainless steel.  
Bottom of the central  
drawers lined in H bull calf leather.  
Two hidden drawers on the sides.  
Firm seat upholstered in H bull  
calf leather or in fabric.

Designer: Philippe Nigro  
Made in France



All-leather version, Canaletto walnut, chocolat H bull calf,  
960394M 04



Leather and fabric version, oak, fauve H bull calf and seigle Cravache fabric,  
960259M 01

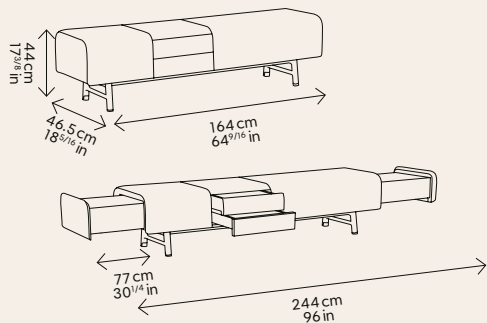

# Cheval d'arçons Les Nécessaires d'Hermès



Oak, fauve H bull calf



Oak, fauve H bull calf and seigle Cravache fabric

## Finishes

### Oak

#### H bull calf leather

fauve                      chocolat

#### H bull calf leather / Cravache

fauve / seigle

### Canaletto walnut

#### H bull calf leather

fauve                      chocolat                      noir ébène

#### H bull calf leather / Cravache

fauve / seigle



# Cheval d'arçons Les Nécessaires d'Hermès



## References

WOOD	FINISH	Worldwide except USA / UK / HK / Chine	USA	UK / HK / Chine
Natural oak	H bull calf leather fauve	960393MW01	960393MU01	960393MW01
	H bull calf leather chocolat	960393MW02	960393MU02	960393MW02
	H bull calf leather fauve / Cravache seigle	960259MW01	961852MU01	961852MG01
Canaletto walnut	H bull calf leather fauve	960394MW01	960394MU01	960394MW01
	H bull calf leather noir ébène	960394MW03	960394MU03	960394MW03
	H bull calf leather chocolat	960394MW04	960394MU04	960394MW04
	TH bull calf leather fauve / Cravache seigle	960354MW01	961853MU01	961853MG01

### Important to know

- The thin protective pigment layer applied to the leather preserves the natural look of the material.
- The grain, pores and other aspects of the hide remain visible.

### Care advice

- To maintain the quality of this product over time, clean regularly with a soft cloth and wipe off any stains immediately with a clean, absorbent cloth.
- For any other maintenance request, please contact Hermès Customer Service.

### Packing information

1 package with a total weight of 109kg.  
Package size: 181 x 63 x 64 cm  
(31<sup>7/8</sup> x 24<sup>13/16</sup> x 25<sup>3/16</sup> in).

# Satellite Tables Les Nécessaires d'Hermès

## Coffee tables

Legs in solid Canaletto walnut or solid oak and feet in brushed stainless steel.

Tabletops in Port-Laurent or Calacatta Viola marble, onyx or travertine (Navona, Romano Classico).

Designer: Philippe Nigro  
Made in France

- + The Satellite tables are available in different sizes and heights, almost like satellites approaching each other in the sky.



**Small model version**, natural oak, ivory onyx, 931173M 01



**Medium model version**, Canaletto walnut, Port-Laurent marble, 940071M 01



**Large model version**, Canaletto walnut, Romano Classico travertine, 960219M 01

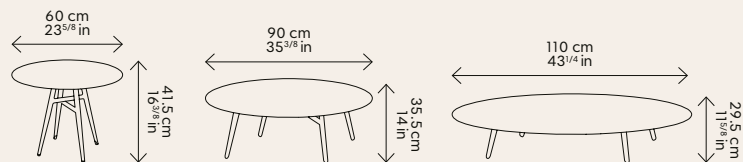

# Satellite Tables Les Nécessaires d'Hermès

## Important to know

The travertine or Calacatta Viola marble have a matt finish while the onyx and Port-Laurent marble have a glossy finish.

The marble sheets reveal unique veins which are intrinsic to the natural stone (caused by oxidised mineral deposits).

Onyx Velluto is a greyish-blue onyx with hints of beige and white.

The colour of the travertine stone varies from brown to yellow depending on the region. It is a porous but very hard stone in warm tones with contrasting veins or streaks of colour. This stone is characterised by the small holes that appear unevenly across its surface.

No two pieces are alike because each stone is unique.



Navona travertine



Romano Classico travertine



Viola Calacatta marble



Ivory onyx



Port-Laurent marble

# Satellite Tables Les Nécessaires d'Hermès



## References

WOOD	FINISH			
Natural oak	Ivory onyx	931173M 01	931172M 01	931171M 01
	Port-Laurent	931179M 01	931178M 01	931177M 01
	Calacatta Viola	960222M 01	960221M 01	960220M 01
	Romano Classico travertine	960216M 01	960215M 01	960214M 01
	Navona travertine	960192M 01	960191M 01	960190M 01
Canaletto walnut	Ivory onyx	940092M 01	940091M 01	940090M 01
	Port-Laurent	940072M 01	940071M 01	940070M 01
	Calacatta Viola	960225M 01	960224M 01	960223M 01
	Romano Classico travertine	960219M 01	960218M 01	960217M 01
	Navona travertine	960195M 01	960194M 01	960193M 01

## Care advice

To clean spills or stains, prepare a mix of rubbing alcohol (70°) and water in the following proportions: 80% alcohol, 20% water. Soak a clean, soft cotton cloth in the alcohol solution, then wring out the excess and gently rub along the table surface. Use a clean, dry cloth to finish.

## Packing information

- Small: 1 package with a total weight of 103 kg.  
Package size: 105 x 85 x 103 cm (41<sup>5/16</sup> x 33<sup>7/16</sup> x 40<sup>9/16</sup> in).  
1 package with a total weight of 23 kg.  
Package size: 68 x 61 x 64 cm (26<sup>3/4</sup> x 24 x 25<sup>3/16</sup> in).
- Medium: 1 package with a total weight of 141 kg.  
Package size: 150 x 115 x 132 cm (59<sup>1/16</sup> x 45<sup>1/4</sup> x 52 in).  
1 package with a total weight of 34 kg.  
Package size: 76.5 x 76.5 x 42 cm (30<sup>1/8</sup> x 30<sup>1/8</sup> x 16<sup>9/16</sup> in).

- Large: 1 package with a total weight of 270 kg.  
Package size: 165 x 145 x 145 cm (64<sup>15/16</sup> x 57<sup>1/16</sup> x 57<sup>1/16</sup> in).  
1 package with a total weight of 42 kg.  
Package size: 110 x 103 x 40 cm (43<sup>5/16</sup> x 40<sup>9/16</sup> x 15<sup>3/4</sup> in).

Consult the video for specific instructions on how to unpack and install the Satellite tables.

# Side table with drawer Les Nécessaires d'Hermès

## Side table with rotating drawer

Legs in solid Canaletto walnut or solid oak and feet in brushed stainless steel.

Metallic tabletop covered in H bull calf leather.

Pivoting drawer in laminated walnut or oak

Designer: Philippe Nigro  
Made in France

+ The hidden compartment under the tabletop is a well-guarded secret.



Small model, Canaletto walnut, chocolat H bull calf, 960409M 04



Large model, natural oak, fauve H bull calf, 960400M 01

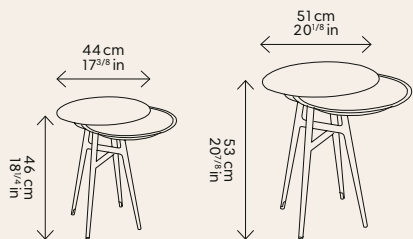

# Side table with drawer Les Nécessaires d'Hermès



Small model, **Canaletto walnut**, chocolat H bull calf



Large model, **natural oak**, fauve H bull calf

## Finishes

### Oak

#### H bull calf leather

fauve      chocolat

### Canaletto walnut

#### H bull calf leather

fauve      chocolat      noir ébène

# Side table with drawer Les Nécessaires d'Hermès



## References

WOOD	FINISH	Small model		Large model	
		Worldwide except USA	USA	Worldwide except USA	USA
Natural oak	H bull calf leather fauve	960401MW01	*	960400MW01	*
	H bull calf leather chocolat	960401MW02	*	960400MW02	*
Canaletto walnut	H bull calf leather fauve	960409MW01	*	960408MW01	*
	H bull calf leather noir ébène	960409MW03	*	960408MW03	*
	H bull calf leather chocolat	960409MW04	*	960408MW04	*

\* Temporarily unavailable for importation.



## Important to know

- The thin protective pigment layer applied to the leather preserves the natural look of the material.
- The grain, pores and other aspects of the hide remain visible.

## Care advice

- To maintain the quality of this product over time, clean regularly with a soft cloth and wipe off any stains immediately with a clean, absorbent cloth.
- For any other maintenance request, please contact Hermès Customer Service.

## Packing information

- GM: 1 package with a total weight of 30 kg. Package size: 64 x 64 x 73 cm (25<sup>3/16</sup> x 25<sup>3/16</sup> x 28<sup>3/4</sup> in).
- PM: 1 package with a total weight of 27 kg. Package size: 60 x 60 x 73 cm (23<sup>5/8</sup> x 23<sup>5/8</sup> x 28<sup>3/4</sup> in).

## Side table Les Nécessaires d'Hermès

### Side table

Legs in solid Canaletto walnut or solid oak and feet in brushed stainless steel.  
Metallic tabletop covered in H bull calf leather.

Designer: Philippe Nigro  
Made in France



Small model, Canaletto walnut, chocolat H bull calf, 960411M 04



Large model, natural oak, chocolat H bull calf, 960402M 02

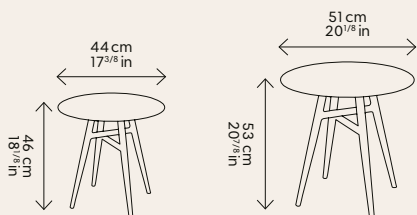



# Side table Les Nécessaires d'Hermès



Small model, **Canaletto walnut**, chocolat H bull calf



Large model, **natural oak**, chocolat H bull calf

## Finishes

### Oak

#### H bull calf leather

fauve      chocolat

### Canaletto walnut

#### H bull calf leather

fauve      chocolat      noir ébène

# Side table Les Nécessaires d'Hermès



## References

WOOD	FINISH	Small model		Large model	
		Worldwide except USA	USA	Worldwide except USA	USA
Natural oak	H bull calf leather fauve	960403MW01	*	960402MW01	*
	H bull calf leather chocolat	960403MW02	*	960402MW02	*
Canaletto walnut	H bull calf leather fauve	960411MW01	*	960410MW01	*
	H bull calf leather noir ébène	960411MW03	*	960410MW03	*
	H bull calf leather chocolat	960411MW04	*	960410MW04	*

\* Temporarily unavailable for importation.



## Important to know

- The thin protective pigment layer applied to the leather preserves the natural look of the material.
- The grain, pores and other aspects of the hide remain visible.

## Care advice

- To maintain the quality of this product over time, clean regularly with a soft cloth and wipe off any stains immediately with a clean, absorbent cloth.
- For any other maintenance request, please contact Hermès Customer Service.

## Packing information

- GM: 1 package with a total weight of 30 kg. Package size: 64 x 64 x 73 cm (25<sup>3/16</sup> x 25<sup>3/16</sup> x 28<sup>3/4</sup> in).
- PM: 1 package with a total weight of 27 kg. Package size: 60 x 60 x 73 cm (25<sup>3/16</sup> x 25<sup>3/16</sup> x 28<sup>3/4</sup> in).

## CARPETS

Cordélie

## FURNITURE

Ancelle d'Hermès  
Atout d'Hermès  
Chaise Conservatoire  
Contour d'Hermès  
Équilibre d'Hermès  
Équipages d'Hermès  
Equis d'Hermès  
Hippodrome d'Hermès  
Karumi  
The Sellier Chair  
Les Nécessaires d'Hermès  
**Les Trotteuses d'Hermès**  
Lignage d'Hermès  
Métiers  
Oria d'Hermès  
Persiennes  
Pippa  
Jean-Michel Frank furniture  
designs by Hermès  
Sillage d'Hermès  
Sofa Sellier  
Tray-Tôt

## LIGHTING

Coulisse  
Halo  
Hécate  
Harnais  
Lanterne d'Hermès  
Pantographe  
Sarazine

# Les Trotteuses d'Hermès

Three heights, three diameters, three porcelain tops with colourful motifs fastened with bridle-leather straps, and a wooden base in solid oak which folds in and out with ease, endow these three small round tables with a nomadic spirit for enhanced versatility. Individually, as a pair, or as a trio, the tables move effortlessly from one space to another around the home. New top designs are now available for a renewed collection.

Designer Hermès Studio

# Side table Les Trotteuses d'Hermès

## Side table

Folding legs in solid oak, straps in bridle leather.

Tabletops in decorated porcelain.

SM Design: *H Boro*, Anne Roussel & Veronika Wildgruber.

MM Design: *Weaving*, Anne Roussel & Veronika Wildgruber.

LM Design: *Chevron vibré*, Gianpaolo Pagni.

Designer: Hermès Studio

Made in France

+ Their name, deriving from the word "trot", expresses the nomadic spirit of these small round tables.



**Small model**, H Boro design, Anne Roussel & Veronika Wildgruber



**Medium model**, Weaving design, Anne Roussel & Veronika Wildgruber



**Large model**, Chevron vibré design, Gianpaolo Pagni

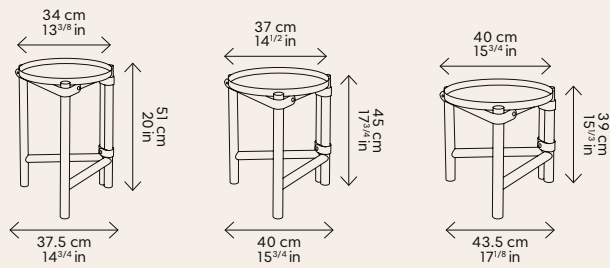

# Side table Les Trotteuses d'Hermès



Small model, H Boro design

Medium model, Weaving design

Large model, Chevron vibré design



## References

### WOOD

Natural oak

### LEATHER

Bridle leather

### Small model

960241M 01

### Medium model

960242M 01

### Large model

960243M 01

## Important to know

Combine three different kinds of expertise dear to Hermès : porcelain, leather and woodworking.

## Care advice

The porcelain tray tops are not dishwasher or microwave-safe as their base is made of cork.

## Packing information

- 1 orange box with a total weight of 5 kg.
  - 1 orange box with a total weight of 8 kg.
- Package size: 61 x 62 x 32 cm.

## CARPETS

Cordélie

## FURNITURE

Ancelle d'Hermès  
Atout d'Hermès  
Chaise Conservatoire  
Contour d'Hermès  
Équilibre d'Hermès  
Équipages d'Hermès  
Equis d'Hermès  
Hippodrome d'Hermès  
Karumi  
The Sellier Chair  
Les Nécessaires d'Hermès  
Les Trotteuses d'Hermès  
**Lignage d'Hermès**  
Métiers  
Oria d'Hermès  
Persiennes  
Pippa  
Jean-Michel Frank furniture  
designs by Hermès  
Sillage d'Hermès  
Sofa Sellier  
Tray-Tôt

## LIGHTING

Coulisse  
Halo  
Hécate  
Harnais  
Lanterne d'Hermès  
Pantographe  
Sarazine

# Lignage d'Hermès

Human and material, black and white, simplicity and solidity. This blue stone table from Hainaut, Belgium, designed by Studio Mumbai, tells a story of an encounter between raw aesthetics and delicate know-how. It is originally presented black, but when engraved it becomes white, illustrating the direct relationship between the material and the artisan's movements. The stonemason uses a ruler to carefully trace lines onto the tabletop, making them appear like rays of light.

Designer Studio Mumbai, Indian architecture and design studio

# Stone tables Lignage d'Hermès

## Side table

Hainaut stone, shaped and chiselled by hand.

Designer: Mumbai Studio  
Made in France

- + The table is made by hand-cutting a single cube of stone. Each of the 800 drawn lines is meticulously chiselled.



Small model, 960237M 01



Large model, 960238M 01

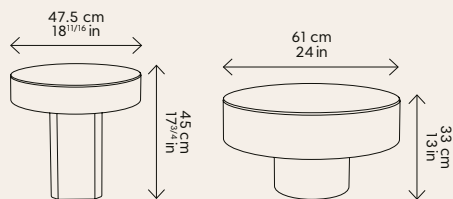



# Stone tables Lignage d'Hermès

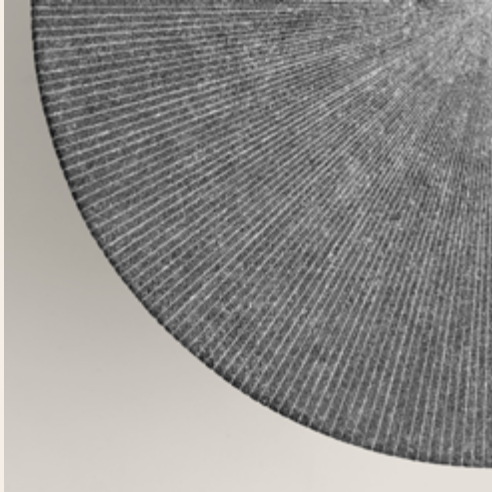

## Reference

### MATERIAL

Hainaut stone

### Small model

960237M 01

### Large model

960238M 01

## Important to know

The lines chiselled in the Hainaut stone are naturally clearer.

## Care advice

- Daily care: remove dust from the surface of your table with a vacuum cleaner.
- In the event of a stain or a liquid spill, wipe it immediately with a clean paper towel.
- If there is a greasy or sticky stain, first remove it with a paper towel, then clean it with a sponge and lukewarm water before wiping the table with a paper towel.

## Packing information

- Small model: 1 package with a total weight of 123 kg. Package size: 69 x 69 x 74 cm (27<sup>3/16</sup> x 27<sup>3/16</sup> x 29<sup>1/8</sup> in).
- Large model: 1 package with a total weight of 176 kg. Package size: 79 x 79 x 60 cm (31<sup>1/8</sup> x 31<sup>1/8</sup> x 23<sup>5/8</sup> in).





## CARPETS

Cordélie

## FURNITURE

Ancelle d'Hermès  
Atout d'Hermès  
Chaise Conservatoire  
Contour d'Hermès  
Équilibre d'Hermès  
Équipages d'Hermès  
Equis d'Hermès  
Hippodrome d'Hermès  
Karumi  
The Sellier Chair  
Les Nécessaires d'Hermès  
Les Trotteuses d'Hermès  
Lignage d'Hermès  
**Métiers**  
Oria d'Hermès  
Persiennes  
Pippa  
Jean-Michel Frank furniture  
designs by Hermès  
Sillage d'Hermès  
Sofa Sellier  
Tray-Tôt

## LIGHTING

Coulisse  
Halo  
Hécate  
Harnais  
Lanterne d'Hermès  
Pantographe  
Sarazine

# Métiers

Enzo Mari, an Italian architect and designer who strived toward simplicity and timelessness in his work, applied a process of elimination to the Hermès Métiers line, unlocking the essence of each piece of furniture. Keeping only the essentials of functionality and purity of form, the refinement of the Métiers collection lies in the close attention paid to the materials. The softness of smooth bull calf leather brushes up against wood polished until silky to the touch. This collection is an ode to craftsmen practising different trades or "métiers": from stone masons to upholsterers, leather workers, saddlers, cabinet-makers or carpenters.

Designer Enzo Mari, Italian architect and designer, 1932 - 2020

# Chair Métiers

## Chair

Structure and legs in Canaletto walnut or oak. Back and seat covered in smooth bull calf leather.

Designer: Enzo Mari  
Made in Italy

- + A light backrest gives support to the back when the armrests are at the perfect height, making it very comfortable to sit in.

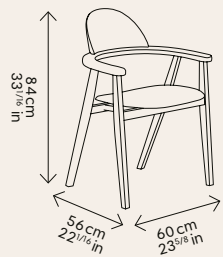

H seat base: 46 cm / 18 1/8 in  
H armrest: 63.5 cm / 25 in



Natural oak version, marine smooth bull calf, 960081M 08



Canaletto walnut version, gold smooth bull calf, 920019M 05

# Chair Métiers



Natural oak, rouge H smooth bull calf



Canaletto walnut, noir smooth bull calf

## Finishes

### Oak

#### Smooth bull calf

noir      rouge H      étoupe      ébène      gold      potiron      tourterelle      marine      chocolat

### Canaletto walnut

#### Smooth bull calf

noir      rouge H      étoupe      ébène      gold      potiron      tourterelle      marine      chocolat

# Chair Métiers



## References

WOOD	FINISH	
Natural oak	Smooth bull calf noir	960081M 01
	Smooth bull calf rouge H	960081M 02
	Smooth bull calf étoupe	960081M 03
	Smooth bull calf ébène	960081M 04
	Smooth bull calf gold	960081M 05
	Smooth bull calf potiron	960081M 06
	Smooth bull calf tourterelle	960081M 07
	Smooth bull calf marine	960081M 08
	Smooth bull calf chocolat	960081M 09
Canaletto walnut	Smooth bull calf noir	920019M 01
	Smooth bull calf rouge H	920019M 02
	Smooth bull calf étoupe	920019M 03
	Smooth bull calf ébène	920019M 04
	Smooth bull calf gold	920019M 05
	Smooth bull calf potiron	920019M 06
	Smooth bull calf tourterelle	920019M 07
	Smooth bull calf marine	920019M 08
	Smooth bull calf chocolat	920019M 09

### Important to know

Contrasting saddle top stitch.

### Care advice

- To maintain the quality of this product over time, clean regularly with a soft cloth and wipe off any stains immediately with a clean, absorbent cloth.
- For any other maintenance request, please contact Hermès Customer Service.

### Packing information

1 package with a total weight of 44 kg.  
 Package size: 79x71x107 cm  
 (31<sup>1/8</sup> x 27<sup>15/16</sup> x 42<sup>1/8</sup> in).

# Desk Métiers

## Desk

Structure and legs in Canaletto walnut or oak. Tabletop covered in smooth bull calf leather.

Designer: Enzo Mari  
Made in Italy

- + This desk is inspired by a carpenter's workbench and has a slightly curved shape that provides comfortable elbow support while working.



Natural oak version, marine smooth bull calf, 960080M 08



Canaletto walnut version, gold smooth bull calf, 920018M 05

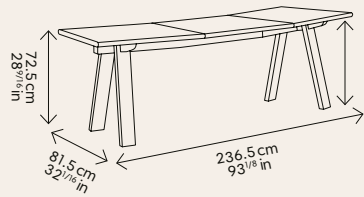

# Desk Métiers



Natural oak, gold smooth bull calf



Canaletto walnut, noir smooth bull calf

## Finishes

### Oak

#### Smooth bull calf

noir      rouge H      étoupe      ébène      gold      potiron      tourterelle      marine      chocolat

### Canaletto walnut

#### Smooth bull calf

noir      rouge H      étoupe      ébène      gold      potiron      tourterelle      marine      chocolat

# Desk Métiers



## References

WOOD	FINISH	
Natural oak	Smooth bull calf noir	960080M 01
	Smooth bull calf rouge H	960080M 02
	Smooth bull calf étoupe	960080M 03
	Smooth bull calf ébène	960080M 04
	Smooth bull calf gold	960080M 05
	Smooth bull calf potiron	960080M 06
	Smooth bull calf tourterelle	960080M 07
	Smooth bull calf marine	960080M 08
	Smooth bull calf chocolat	960080M 09
Canaletto walnut	Smooth bull calf noir	920018M 01
	Smooth bull calf rouge H	920018M 02
	Smooth bull calf étoupe	920018M 03
	Smooth bull calf ébène	920018M 04
	Smooth bull calf gold	920018M 05
	Smooth bull calf potiron	920018M 06
	Smooth bull calf tourterelle	920018M 07
	Smooth bull calf marine	920018M 08
	Smooth bull calf chocolat	920018M 09

### Important to know

Several skins are needed to cover the desk top. Because the leather is very natural and sparsely covered, the more contrasting effect of the spine can often be seen in the centre.

### Care advice

- To maintain the quality of this product over time, clean regularly with a soft cloth and wipe off any stains immediately with a clean, absorbent cloth.
- For any other maintenance request, please contact Hermès Customer Service.

### Packing information

1 package with a total weight of 157 kg.  
Package size: 250 x 98 x 95 cm  
(98<sup>7/16</sup> x 38<sup>7/16</sup> x 37<sup>3/8</sup> in).

# Storage coffer Métiers

## Storage coffer

Structure in Canaletto walnut or oak.  
Tabletop with decor in Canaletto walnut or oak marquetry.  
Pivoting coffer covered in smooth bull calf leather.

Designer: Enzo Mari  
Made in Italy

- + The natural complement to the office.
- + A double bottom provides clever storage.



Oak version, marine smooth bull calf, 960082M 08



Canaletto walnut version, gold smooth bull calf, 920020M 05

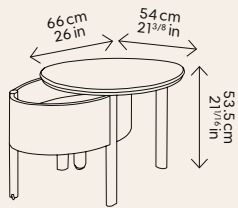

Deployed  
L 92 x H 53,5 x D 54 cm  
L 36<sup>1/4</sup> x D 21<sup>1/8</sup> x H 21<sup>1/4</sup> in

Closed  
L 66 x H 53,5 x D 54 cm  
L 26 x D 21<sup>1/8</sup> x H 21<sup>3/8</sup> in



# Storage coffer Métiers



Natural oak, gold smooth bull calf



Canaletto walnut, noir smooth bull calf

## Finishes

### Oak

#### Smooth bull calf

noir      rouge H      étoupe      ébène      gold      potiron      tourterelle      marine      chocolat

### Canaletto walnut

#### Smooth bull calf

noir      rouge H      étoupe      ébène      gold      potiron      tourterelle      marine      chocolat

# Storage coffer Métiers



## References

WOOD	FINISH	
Natural oak	Smooth bull calf noir	960082M 01
	Smooth bull calf rouge H	960082M 02
	Smooth bull calf étoupe	960082M 03
	Smooth bull calf ébène	960082M 04
	Smooth bull calf gold	960082M 05
	Smooth bull calf potiron	960082M 06
	Smooth bull calf tourterelle	960082M 07
	Smooth bull calf marine	960082M 08
	Smooth bull calf chocolat	960082M 09
Canaletto walnut	Smooth bull calf noir	920020M 01
	Smooth bull calf rouge H	920020M 02
	Smooth bull calf étoupe	920020M 03
	Smooth bull calf ébène	920020M 04
	Smooth bull calf gold	920020M 05
	Smooth bull calf potiron	920020M 06
	Smooth bull calf tourterelle	920020M 07
	Smooth bull calf marine	920020M 08
	Smooth bull calf chocolat	920020M 09

### Care advice

- To maintain the quality of this product over time, clean regularly with a soft cloth and wipe off any stains immediately with a clean, absorbent cloth.
- For any other maintenance request, please contact Hermès Customer Service.

### Packing information

1 package with a total weight of 47 kg.  
 Package size: 80 x 68 x 77 cm  
 (3<sup>1</sup>/<sub>2</sub> x 26<sup>3</sup>/<sub>4</sub> x 30<sup>5</sup>/<sub>16</sub> in).

# Tables Métiers

## Round table and oval table

Metallic structure and legs covered in smooth bull calf leather.

Marble tabletop (Breccia Aurora, Calacatta Carrara, Arabescato Corchia, Vert Alpi, Emperador, Calacatta Viola) or travertine (Navona, Romano Classico).

Designer: Enzo Mari  
Made in Italy



Round table, Arabescato Corchia marble, noir smooth bull calf, 960078M 01



Oval table, Brown Emperador marble, chocolat smooth bull calf, 920026M 06

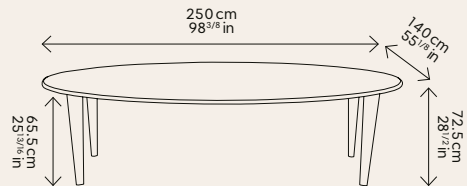
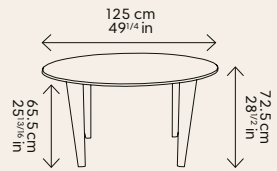

# Tables Métiers



Navona travertine, gold smooth bull calf, round table, 960227M 01



Romano Classico travertine, étoupe smooth bull calf, round table, 960203M 03



Breccia Aurora marble, tourterelle smooth bull calf, round table, 920022M 06



Alpi Verde marble, chocolat smooth bull calf, round table, 960076M 09

## Finishes

### Navona travertine

#### Smooth bull calf

étoupe      ébène      gold

chocolat

### Romano Classico travertine

#### Smooth bull calf

étoupe      ébène      gold

chocolat

### Breccia Aurora marble

#### Smooth bull calf

noir      rouge H      étoupe

ébène      gold      tourterelle

chocolat

### Alpi Verde marble

#### Smooth bull calf

noir      étoupe      ébène

tourterelle      chocolat

# Tables Métiers



Arabescato Corchia marble, marine smooth bull calf, round table, 960078M 07



Calacatta Carrara marble, noir smooth bull calf, round table, 920021M 01



Brown Emperador marble, rouge H smooth bull calf, round table, 920023M 02



Calacatta Viola marble, ébène smooth bull calf, round table, 960207M 03

## Finishes

### Arabescato Corchia marble

#### Smooth bull calf

noir	rouge H	étoupe
ébène	gold	tourterelle
marine	chocolat	

### Calacatta Carrara marble

#### Smooth bull calf

noir	rouge H	étoupe
ébène	gold	tourterelle
marine	chocolat	

### Brown Emperador marble

#### Smooth bull calf

noir	rouge H	étoupe
ébène	gold	chocolat

### Calacatta Viola marble



















#### Smooth bull calf

noir	rouge H	ébène
chocolat		

# Tables Métiers



## References

	Smooth bull calf noir	Smooth bull calf rouge H	Smooth bull calf étoupe	Smooth bull calf ébène	Smooth bull calf gold	Smooth bull calf tourterelle	Smooth bull calf marine	Smooth bull calf chocolat
<b>ROUND TABLE</b> 								
Alpi Verde marble	960076M 01		960076M 03	960076M 04		960076M 06		960076M 09
Arabescato Corchia marble	960078M 01	960078M 02	960078M 03	960078M 04	960078M 05	960078M 06	960078M 07	960078M 08
Breccia Aurora marble	920022M 01	920022M 02	920022M 03	920022M 04	920022M 05	920022M 06		920022M 09
Calacatta Carrara marble	920021M 01	920021M 02	920021M 03	920021M 04	920021M 05	920021M 06	920021M 07	920021M 08
Brown Emperador marble	920023M 01	920023M 02	920023M 03	920023M 04	920023M 05			920023M 06
Calacatta Viola marble	960207M 01	960207M 02		960207M 03				960207M 04
Romano Classico travertine			960203M 03	960203M 02	960203M 01			960203M 04
Navona travertine			960227M 03	960227M 02	960227M 01			960227M 04
<b>OVAL TABLE</b> 								
Alpi Verde marble	960077M 01		960077M 03	960077M 04		960077M 06		960077M 09
Arabescato Corchia marble	960079M 01	960079M 02	960079M 03	960079M 04	960079M 05	960079M 06	960079M 07	960079M 08
Breccia Aurora marble	920025M 01	920025M 02	920025M 03	920025M 04	920025M 05	920025M 06		920025M 07
Calacatta Carrara marble	920024M 01	920024M 02	920024M 03	920024M 04	920024M 05	920024M 06	920024M 07	920024M 08
Brown Emperador marble	920026M 01	920026M 02	920026M 03	920026M 04	920026M 05			920026M 06
Calacatta Viola marble	960206M 01	960206M 02		960206M 03				960206M 04
Romano Classico travertine			960202M 03	960202M 02	960202M 01			960202M 04
Navona travertine			960226M 03	960226M 02	960226M 01			960226M 04

### Important to know

- The marble sheets reveal unique veins which are intrinsic to the natural stone (caused by oxidised mineral deposits).
- Onyx Velluto is a greyish-blue onyx with hints of beige and white.
- The colour of the Travertine stone varies from brown to yellow depending on the region. It is a porous but very hard stone in warm tones with contrasting veins or streaks of colour. This stone is characterised by the small holes that appear unevenly across its surface.
- No two pieces are alike because each stone is unique.

### Care advice

- To clean spills or stains, prepare a mix of rubbing alcohol (70°) and water in the following proportions: 80% alcohol, 20% water.
- Soak a clean, soft cotton cloth in the alcohol solution, then wring out the excess and gently rub along the table surface. Use a clean, dry cloth to finish.

### Packing information

- Oval table: 1 package with a total weight of 35 kg. Package size: 88 x 81 x 24 cm (34<sup>5/8</sup> x 31<sup>7/8</sup> x 9<sup>7/16</sup> in). 1 package with a total weight of 42 kg. Package size: 95 x 97 x 29 cm (37<sup>3/8</sup> x 38<sup>3/16</sup> x 11<sup>7/16</sup> in).

- 1 package with a total weight of 122 kg. Packages size: 144 x 121 x 152 cm (56<sup>11/16</sup> x 47<sup>5/8</sup> x 59<sup>13/16</sup> in).
- Round table: 1 package with a total weight of 35 kg. Package size: 88 x 81 x 24 cm (34<sup>5/8</sup> x 31<sup>7/8</sup> x 9<sup>7/16</sup> in). 1 package with a total weight of 102 kg. Package size: 222 x 118 x 30 cm (87<sup>3/8</sup> x 46<sup>7/16</sup> x 11<sup>13/16</sup> in).
- 1 package with a total weight of 280 kg. Package size: 269 x 81 x 167 cm (105<sup>15/16</sup> x 31<sup>7/8</sup> x 65<sup>3/4</sup> in).

## CARPETS

Cordélie

## FURNITURE

Ancelle d'Hermès

Atout d'Hermès

Chaise Conservatoire

Contour d'Hermès

Équilibre d'Hermès

Équipages d'Hermès

Equis d'Hermès

Hippodrome d'Hermès

Karumi

The Sellier Chair

Les Nécessaires d'Hermès

Les Trotteuses d'Hermès

Lignage d'Hermès

Métiers

**Oria d'Hermès**

Persiennes

Pippa

Jean-Michel Frank furniture

designs by Hermès

Sillage d'Hermès

Sofa Sellier

Tray-Tôt

## LIGHTING

Coulisse

Halo

Hécate

Harnais

Lanterne d'Hermès

Pantographe

Sarazine

# Oria d'Hermès

The Oria d'Hermès armchair and chair by Rafael Moneo were designed in three dimensions, striking a balance between style and sobriety.

The skill of the craftsman shines through in the natural oak frame, H bull calf leather back and traditional cane seat.

Designer Rafael Moneo, Spanish architect

# Chair & armchair Oria d'Hermès

## Chair and armchair

Structure in oak.  
Caned seat and backrest  
in fawn H bull calf leather.

Designer: Rafael Moneo  
Made in France

- + Its name refers to the street in Madrid where Rafael Moneo lived, and where he first designed this chair in the early 1960s for his own personal use.

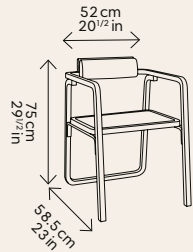

D base seat: 38.5 cm / 15 1/8 in  
H base seat: 45 cm / 17 3/4 in  
H armrest: 69 cm / 27 1/8 in

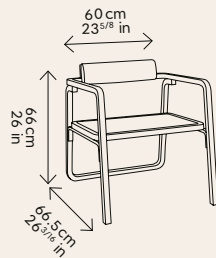

D base seat: 43.5 cm / 17 1/8 in  
H base seat: 39 cm / 15 3/8 in  
H armrest: 61.5 cm / 24 3/16 in



Chair, natural oak, fauve H bull calf, 961855M 01



Armchair, natural oak, fauve H bull calf, 961556M 01



# Chair & armchair Oria d'Hermès



## References

WOOD	LEATHER	CHAIR		ARMCHAIR	
		Worldwide except USA	USA	Worldwide except USA	USA
Natural oak	Fauve H bull calf	961855MW01	961855MU01	961556MW01	961556MU01

### Important to know

- Caned seat handwoven in France.
- Some of the strand ends are deburred (burned off) to make sure they lie completely flat when woven, leaving slightly blackened marks.

### Care advice

- To maintain the quality of this product over time, clean regularly with a soft cloth and wipe off any stains immediately with a clean, absorbent cloth.
- For any other maintenance request, please contact Hermès Customer Service.

### Packing information

- 1 package with a total weight of 53 kg.  
Package size : 85 x 90 x 101 cm  
(33<sup>7/16</sup> x 35<sup>7/16</sup> x 39<sup>3/4</sup> in).

## CARPETS

Cordélie

## FURNITURE

Ancelle d'Hermès  
Atout d'Hermès  
Chaise Conservatoire  
Contour d'Hermès  
Équilibre d'Hermès  
Équipages d'Hermès  
Equis d'Hermès  
Hippodrome d'Hermès  
Karumi  
The Sellier Chair  
Les Nécessaires d'Hermès  
Les Trotteuses d'Hermès  
Lignage d'Hermès  
Métiers  
Oria d'Hermès  
**Persiennes**  
Pippa  
Jean-Michel Frank furniture  
designs by Hermès  
Sillage d'Hermès  
Sofa Sellier  
Tray-Tôt

## LIGHTING

Coulisse  
Halo  
Hécate  
Harnais  
Lanterne d'Hermès  
Pantographe  
Sarazine

# Persiennes

The Persiennes bookcase is an exceptional piece of furniture that is an ode to the rare technique of hand-applied straw marquetry. The opposing inclines of its shelves allow the light to dance off this natural material and make it shine like gold.

Designer Hermès Studio

# Bookcase Persiennes

## Bookcase

Wooden structure covered with waxed natural rye. Straw marquetry.

Designer: Hermès Studio  
Made in France

+ Just as a louvre blind is made up of a series of inclined slats, this bookcase plays on the same open slatwork, although from the front all that's visible is its beautiful straw marquetry.

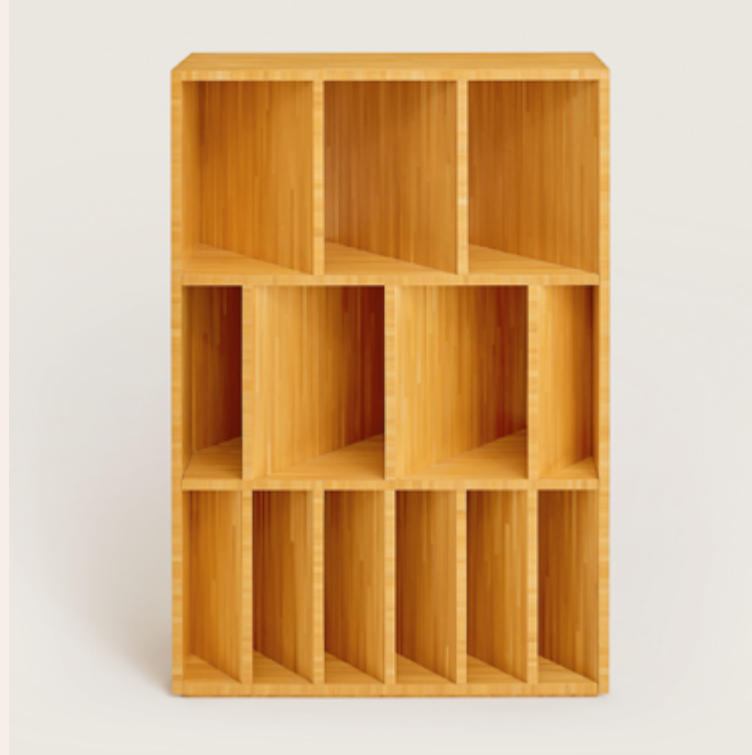
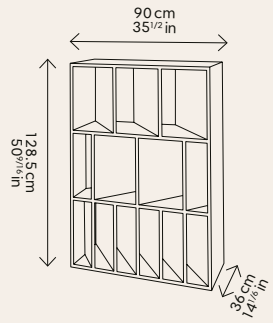

Bookcase, straw marquetry, 960162M 01

# Bookcase Persiennes

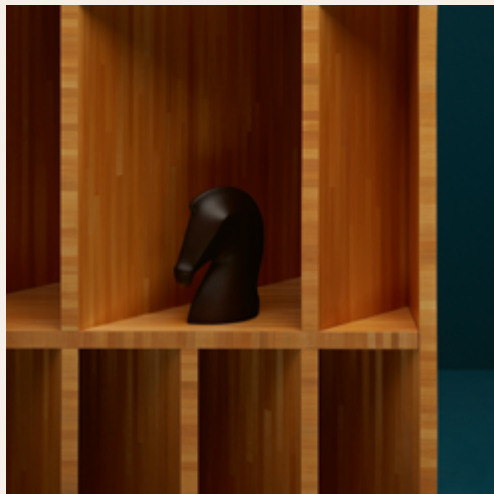

## Reference

### MATERIAL

Straw marquetry

Bookcase

960162M 01

### Care advice

- For the piece to retain its quality over time, it should be cleaned with a soft cloth and any spills should be wiped off immediately using a clean, absorbent cloth.
- If you have any other queries about furniture care, please contact Hermès Customer Service.

### Packing information

1 package with a total weight of 113 kg.  
Package size: 113 x 57 x 165 cm  
(44<sup>1/2</sup> x 22<sup>7/16</sup> x 64<sup>5/16</sup> in).

## CARPETS

Cordélie

## FURNITURE

Ancelle d'Hermès  
Atout d'Hermès  
Chaise Conservatoire  
Contour d'Hermès  
Équilibre d'Hermès  
Équipages d'Hermès  
Equis d'Hermès  
Hippodrome d'Hermès  
Karumi  
The Sellier Chair  
Les Nécessaires d'Hermès  
Les Trotteuses d'Hermès  
Lignage d'Hermès  
Métiers  
Oria d'Hermès  
Persiennes  
**Pippa**  
Jean-Michel Frank furniture  
designs by Hermès  
Sillage d'Hermès  
Sofa Sellier  
Tray-Tôt

## LIGHTING

Coulisse  
Halo  
Hécate  
Harnais  
Lanterne d'Hermès  
Pantographe  
Sarazine

# Pippa

The Pippa line was imagined by Rena Dumas in the Hermès spirit of “moving with elegance”. It combines the warmth and softness of wood (pearwood or maplewood) with the suppleness and resilience of leather (natural cowhide or Clémence bull calf leather).

Designer Rena Dumas, French interior designer, 1937 - 2009

# Folding armchair & stool Pippa

## Folding armchair and stool

Available in natural maple and Clémence bull calf leather, in ebonised maple and Clémence bull calf leather or in pearwood and natural cowhide leather.

Designer:

Folding armchair: Rena Dumas

Stool: Rena Dumas & Peter Coles

Made in Italy

- + Designed in 1986, this folding easy-to-move furniture draws directly on the nomadic spirit of the pieces used in 17th and 18th-century Europe by members of high society, who wished to travel in the same comfort as they enjoyed at home.



Folding armchair, pearwood, natural cowhide, brass finish, 900133M 01



Stool, pearwood, natural cowhide, brass finish, 900130M 01

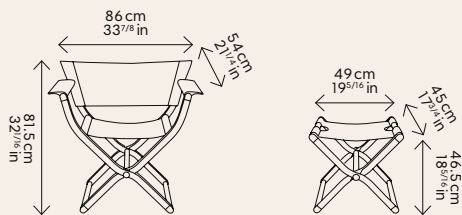

# Folding armchair & stool Pippa



Pearwood, natural cowhide, brass finish



Natural maple, gold Clémence bull calf, brass finish



Ebonised maple, ébène Clémence bull calf, nickel finish



Ebonised maple, rouge H Clémence bull calf, nickel finish

## Finishes

### Pearwood



### Pearwood



### Natural cowhide

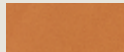

naturel

### Clémence bull calf



gold

### Brass finish



### Brass finish



### Natural maple



### Clémence bull calf



gold

### Brass finish



### Ebonised maple

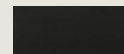

### Clémence bull calf



ébène

### Nickel finish



### Ebonised maple

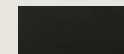

### Clémence bull calf

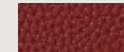

rouge H

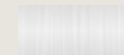

### Nickel finish



# Folding armchair & stool Pippa



## References

WOOD	FINITION		
Pearwood	Brass finish / Natural cowhide	900133M 01	900130M 01
	Brass finish / Clémence bull calf gold	900613M 01	900614M 01
Natural maple	Brass finish / Clémence bull calf gold	900643M 00	900644M 00
Ebonised maple	Nickel finish / Clémence bull calf ébène	900099M 02	900102M 02
	Nickel finish / Clémence bull calf rouge H	900099M 01	900102M 01

### Important to know

- Precious woods worked by master cabinet-makers combine with exquisite traditional leathercrafting skills.
- Because of its complexity, the folding stand can only tolerate perfect materials and a flawless finish.

### Care advice

- For the piece to retain its quality over time, it should be cleaned with a soft cloth and any spills should be wiped off immediately using a clean, absorbent cloth.
- If you have any other queries about furniture care, please contact Hermès Customer Service.

### Packing information

- Folding armchair:  
1 package with a total weight of 28 kg.  
Package size: 115 x 39 x 71 cm  
(45<sup>1/4</sup> x 15<sup>3/8</sup> x 27<sup>15/16</sup> in).
- Folding stool:  
1 package with a total weight of 15 kg.  
Package size: 78 x 16 x 50 cm  
(30<sup>11/16</sup> x 6<sup>5/16</sup> x 19<sup>11/16</sup> in).



# Méridienne Pippa

## Méridienne

Fixed centre piece, two adjustable or tilting sides.

Available in natural maple and Clémence bull calf leather or in pearwood and natural cowhide leather.

To associated with the mattress in fawn H bull calf leather.

Fifteen removable cushions on a flat surface of the same leather, white piping, headrest in fawn H bull calf leather.

Designer: Rena Dumas & Peter Coles  
Mattress creation: RDAI  
Made in Italy

+ Pippa was the nickname of Peter Coles, who collaborated with Rena Dumas to design this timeless collection.



Méridienne, pearwood, natural cowhide, brass finish, 900132M 01



Méridienne, natural maple, gold Clémence bull calf, brass finish.  
Méridienne mattress, fauve H bull calf, white piping.

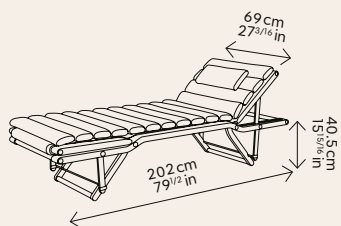

Back raised: H 75 cm / 29 1/2 in

# Méridienne Pippa



## Finishes

WOOD	FINITION	Méridienne	Méridienne mattress	
			Worldwide except USA	USA
Pearwood	Brass finish / Natural cowhide	900132M 01		
Natural maple	Brass finish / Clémence bull calf gold	900640M 00		
	Fauve H bull calf, white piping		960373MW00	960373MU00

## Important to know

- Precious woods worked by master cabinet-makers combine with exquisite traditional leathercrafting skills.
- Because of its complexity, the folding stand can only tolerate perfect materials and a flawless finish.

## Care advice

- For the piece to retain its quality over time, it should be cleaned with a soft cloth and any spills should be wiped off immediately using a clean, absorbent cloth.
- If you have any other queries about furniture care, please contact Hermès Customer Service.

## Packing information

1 package with a total weight of 50 kg.  
Package size: 210x80x28 cm  
(82<sup>11/16</sup>x31<sup>1/2</sup>x11 in).

# Écritoire desk Pippa

## Écritoire desk

Available in natural maple and Clémence bull calf leather, in ebonised maple and Clémence bull calf leather or in pearwood and natural cowhide leather.

Designer: Rena Dumas & Peter Coles  
Made in Italy

- + Pippa was the nickname of Peter Coles, who collaborated with Rena Dumas to design this timeless collection.



Open écritoire desk, maple, Clémence bull calf, brass finish, 900639M 00



Closed écritoire desk, maple, Clémence bull calf, brass finish, 900639M 00

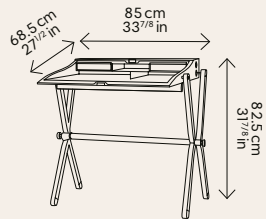

Open	Closed
L 85 x H 82.5 x D 68.5 cm	L 85 x H 82.5 x D 42 cm
33 <sup>7/16</sup> x 32 <sup>1/2</sup> x 27 in	33 <sup>7/16</sup> x 32 <sup>1/2</sup> x 16 <sup>9/16</sup> in

# Écritoire desk Pippa



Pearwood, natural cowhide, brass finish, 900131M 01



Natural maple, gold Clémence bull calf, brass finish, 900639M 00



Ebonised maple, ébène Clémence bull calf, nickel finish, 900098M 02



Ebonised maple, rouge H Clémence bull calf, nickel finish, 900098M 01

## Finishes

Pearwood

Pearwood

Natural maple

Ebonised maple

Ebonised maple

Natural cowhide

Clémence bull calf

Clémence bull calf

Clémence bull calf

Clémence bull calf

naturel

gold

gold

ébène

rouge H

Brass finish

Brass finish

Brass finish

Nickel finish

Nickel finish

# Écritoire desk Pippa



## References

WOOD	FINISH	
Pearwood	Brass finish / Natural cowhide	900131M 01
	Brass finish / Clémence bull calf gold	900609M 00
Natural maple	Brass finish / Clémence bull calf gold	900639M 00
Ebonised maple	Nickel finish / Clémence bull calf ébène	900098M 02
	Nickel finish / Clémence bull calf rouge H	900098M 01

## Important to know

- Precious woods worked by master cabinet-makers combine with exquisite traditional leathercrafting skills.
- Because of its complexity, the folding stand can only tolerate perfect materials and a flawless finish.

## Care advice

- For the piece to retain its quality over time, it should be cleaned with a soft cloth and any spills should be wiped off immediately using a clean, absorbent cloth.
- If you have any other queries about furniture care, please contact Hermès Customer Service.

## Packing information

1 package with a total weight of 26 kg.  
Package size: 95 x 21 x 69 cm  
(37<sup>3/8</sup> x 8<sup>1/4</sup> x 27<sup>3/16</sup> in).

# Console & Side table Pippa

## Console and side table

Available in natural maple,  
in ebonised maple or in pearwood.

Designer: Rena Dumas  
Made in Italy

- + Designed in 1986, this folding easy-to-move furniture draws directly on the nomadic spirit of the pieces used in 17th and 18th-century Europe by members of high society, who wished to travel in the same comfort as they enjoyed at home.



Console, natural maple, brass finish, 900630M 00



Side table, natural maple, brass finish, 900631M 00

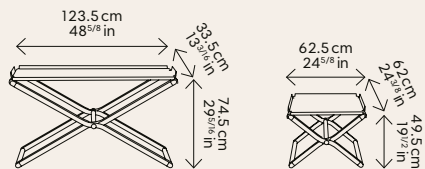

# Console & Side table Pippa



Pearwood, brass finish



Natural maple, brass finish



Ebonised maple, nickel finish

## Finishes

Pearwood

Brass finish

Natural maple

Brass finish



Ebonised maple

Nickel finish

# Console & Side table Pippa



## References

WOOD	FINISH		
Pearwood	Brass finish	900011M 00	900012M 00
Natural maple	Brass finish	900630M 00	900631M 00
Ebonised maple	Nickel finish	900089M 00	900090M 00

### Important to know

- Precious woods worked by master cabinet-makers combine with exquisite traditional leathercrafting skills.
- Because of its complexity, the folding stand can only tolerate perfect materials and a flawless finish.

### Care advice

- For the piece to retain its quality over time, it should be cleaned with a soft cloth and any spills should be wiped off immediately using a clean, absorbent cloth.
- If you have any other queries about furniture care, please contact Hermès Customer Service.

### Packing information

- Console:  
1 package with a total weight of 26 kg.  
Package size: 125 x 35 x 30 cm  
(49<sup>3/16</sup> x 13<sup>3/4</sup> x 11<sup>13/16</sup> in).
- Side table:  
1 package with a total weight of 23 kg.  
Package size: 75 x 70 x 33 cm  
(29<sup>1/2</sup> x 27<sup>7/16</sup> x 13 in).



# Screen Pippa

## Screen

Pear articulated wood structure.  
Panels covered in leather (natural cowhide).

Designer: Rena Dumas  
Made in France

- + Designed in 1986, this folding easy-to-move furniture draws directly on the nomadic spirit of the pieces used in 17th and 18th-century Europe by members of high society, who wished to travel in the same comfort as they enjoyed at home.

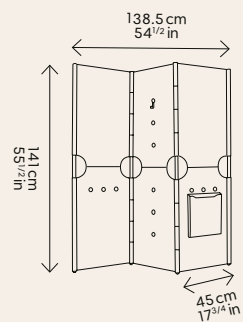

Open  
L 138.5 x H 141 x D 3.5 cm  
L 54 1/2 x H 55 1/2 x D 1 3/8

Closed  
L 45 x H 141 x D 5 cm  
L 17 3/4 x H 55 1/2 x D 2 in



Screen, pearwood, natural cowhide, brass finish, 900608M 00

## Important to know

- Precious woods worked by master cabinet-makers combine with exquisite traditional leathercrafting skills.

## Care advice

- For the piece to retain its quality over time, it should be cleaned with a soft cloth and any spills should be wiped off immediately using a clean, absorbent cloth.
- If you have any other queries about furniture care, please contact Hermès Customer Service.

## Packing information

1 package with a total weight of 28 kg.  
Package size: 150 x 62 x 23 cm  
(59 1/16 x 24 7/16 x 9 1/16 in).

# Jean-Michel Frank furniture designs by Hermès

Jean-Michel Frank (1895 - 1941), a figurehead of the decorative arts, was the most influential designer and decorator of the 1920s and 1930s. With his "modest luxury" style – a precursor to minimalism – he stripped away any superfluous decoration in search of simplicity. His spaces invited meditation. His lines were rigorous, his forms simple, his materials natural or sophisticated.

In 1924, Jean-Michel Frank met Jean-René Guerrand, son-in-law of Émile Hermès, and commissioned him to upholster his comfortable armchairs and sofas. Their partnership was to last the rest of the designer's lifetime. With Jean-Michel Frank, Hermès pushed the envelope of its saddlery and harness-making expertise to upholster pieces of furniture and wall coverings. These re-releases of those timeless minimalist pieces – identical to the originals – are crafted with exceptional expertise in tapestry and upholstery.

Designer Jean-Michel Frank, French interior designer, 1895 - 1941

## CARPETS

Cordélie

## FURNITURE

Ancelle d'Hermès  
Atout d'Hermès  
Chaise Conservatoire  
Contour d'Hermès  
Équilibre d'Hermès  
Équipages d'Hermès  
Equis d'Hermès  
Hippodrome d'Hermès  
Karumi  
The Sellier Chair  
Les Nécessaires d'Hermès  
Les Trotteuses d'Hermès  
Lignage d'Hermès  
Métiers  
Oria d'Hermès  
Persiennes  
Pippa  
**Jean-Michel Frank furniture  
designs by Hermès**  
Sillage d'Hermès  
Sofa Sellier  
Tray-Tôt

## LIGHTING

Coulisse  
Halo  
Hécate  
Harnais  
Lanterne d'Hermès  
Pantographe  
Sarazine

# Club armchair

Jean-Michel Frank furniture designs by Hermès

## "Comfortable" club armchair

Traditional upholstery.  
Structure in natural beech lined in leather  
(sheepskin, smooth calfskin, H bull calf).  
Feet in solid oak.

Designer: Re-edition in partnership  
with the Frank family  
and the Jean-Michel Frank Committee,  
faithful to the original work.  
Made in Italy

+ An iconic piece of modern furniture.  
With no visible wood, its straight  
lines and pared-back form are simply  
contained within a cube.

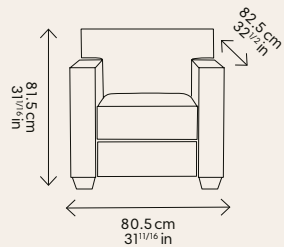

D seat base: 61 cm / 24 in  
H seat base: 43.5 cm / 17 1/8 in  
H armrest: 64 cm / 25 3/16 in



Sheepskin version



Leather version

# Club armchair

Jean-Michel Frank furniture designs by Hermès



Sheepskin



Noir ébène H bull calf leather



Gold smooth calfskin

## Finishes

### Sheepskin

naturel

### H bull calf leather

noir ébène

ivoire

étoupe

ébène

gold

fauve

### Smooth calfskin

ivoire

étoupe

ébène

gold

**Important to know:** Contrast stitching in white thread (except for the ebony black colourway, which have tone-on-tone stitching).

# Club armchair

Jean-Michel Frank furniture designs by Hermès



## References

LEATHER	FINISH	Worldwide except USA	USA
Sheepskin	Sheepskin naturel	960245MW01	960245MU01
	H bull calf leather noir ébène	960357MW01	960357MU01
H bull calf leather	H bull calf leather ivoire	960357MW02	960357MU02
	H bull calf leather étoupe	960357MW03	960357MU03
	H bull calf leather ébène	960357MW04	960357MU04
	H bull calf leather gold	960357MW05	960357MU05
	H bull calf leather fauve	960357MW06	960357MU06
Smooth calfskin	Smooth calfskin ivoire	960244MW02	960244MU02
	Smooth calfskin étoupe	960244MW03	960244MU03
	Smooth calfskin ébène	960244MW04	960244MU04
	Smooth calfskin gold	960244MW05	960244MU05

## Care advice

- For the piece to retain its quality over time, it should be cleaned with a soft cloth and any spills should be wiped off immediately using a clean, absorbent cloth.
- To take care of sheepskin finish, vacuum with a soft brush once a month to remove dust. Blot any stains with white paper towels as quickly as possible
- If you have any other queries about furniture care, please contact Hermès Customer Service.

## Packing information

1 package with a total weight of 120 kg.  
Package size: 105.5 x 105.5 x 109 cm  
(41<sup>5/16</sup> x 41<sup>5/16</sup> x 42<sup>15/16</sup> in).

## 2-seater sofa

Jean-Michel Frank furniture designs by Hermès

### 2-seater sofa

Traditional upholstery.  
Structure in natural beech lined in leather  
(sheepskin, smooth calfskin, H bull calf).  
Feet in solid oak

Designer: Re-edition in partnership  
with the Frank family  
and the Jean-Michel Frank Committee,  
faithful to the original work.  
Made in Italy

+ A piece that typifies the 1930s and  
Jean-Michel Frank's style.



Sheepskin version



Leather version

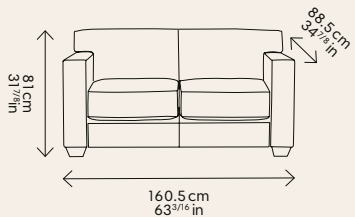

D seat base: 64 cm / 25 1/4 in  
H seat base: 43.5 cm / 17 1/8 in  
H armrest: 64 cm / 25 3/16 in

## 2-seater sofa

Jean-Michel Frank furniture designs by Hermès



Sheepskin



Noir ébène H bull calf leather



Ivoire smooth calfskin

### Finishes

#### Sheepskin

naturel

#### H bull calf leather

noir ébène

ivoire

étoupe

ébène

gold

fauve

#### Smooth calfskin

ivoire

étoupe

ébène

gold

**Important to know:** Contrast stitching in white thread (except for the ebony black colourway, which have tone-on-tone stitching).

# 2-seater sofa

## Jean-Michel Frank furniture designs by Hermès



### References

LEATHER	FINITION	Worldwide except USA	USA
Sheepskin	Sheepskin naturel	961820MW01	961820MU01
	H bull calf leather noir ébène	960358MW01	960358MU01
	H bull calf leather ivoire	960358MW02	960358MU02
H bull calf leather	H bull calf leather étoupe	960358MW03	960358MU03
	H bull calf leather ébène	960358MW04	960358MU04
	H bull calf leather gold	960358MW05	960358MU05
	H bull calf leather fauve	960358MW06	960358MU06
Smooth calfskin	Smooth calfskin ivoire	960246MW02	960246MU02
	Smooth calfskin étoupe	960246MW03	960246MU03
	Smooth calfskin ébène	960246MW04	960246MU04
	Smooth calfskin gold	960246MW05	960246MU05

### Care advice

- For the piece to retain its quality over time, it should be cleaned with a soft cloth and any spills should be wiped off immediately using a clean, absorbent cloth.
- To take care of sheepskin finish, vacuum with a soft brush once a month to remove dust. Blot any stains with white paper towels as quickly as possible
- If you have any other queries about furniture care, please contact Hermès Customer Service.

### Packing information

1 package with a total weight of 183 kg.  
 Package size: 186 x 112 x 104 cm  
 (73<sup>1/4</sup> x 44<sup>1/16</sup> x 40<sup>15/16</sup> in).



# 3-seater sofa

Jean-Michel Frank furniture designs by Hermès

## 3-seater sofa

Traditional upholstery.  
Structure in natural beech lined in leather (sheepskin, smooth calfskin, H bull calf).  
Feet in solid oak

Designer: Re-edition in partnership with the Frank family and the Jean-Michel Frank Committee, faithful to the original work.  
Made in Italy

+ A piece that typifies the 1930s and Jean-Michel Frank's style.



Sheepskin naturel version



Leather version

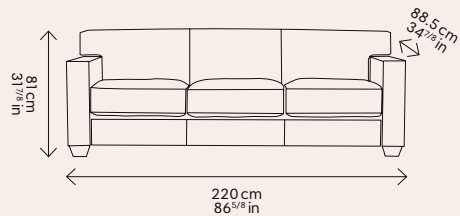

D seat base: 64 cm / 25<sup>1</sup>/<sub>4</sub> in  
H seat base: 43.5 cm / 17<sup>1</sup>/<sub>8</sub> in  
H armrest: 64 cm / 25<sup>1</sup>/<sub>4</sub> in

# 3-seater sofa

Jean-Michel Frank furniture designs by Hermès



Sheepskin naturel



Fauve H bull calf leather



Ébène Smooth calfskin

## Finishes

### Sheepskin

naturel

### H bull calf leather

noir ébène

ivoire

étoupe

ébène

gold

fauve

### Smooth calfskin

ivoire

étoupe

ébène

gold

**Important to know:** Contrast stitching in white thread (except for the ebony black colourway, which have tone-on-tone stitching).

# 3-seater sofa

Jean-Michel Frank furniture designs by Hermès



## References

LEATHER	FINISH	Worldwide except USA	USA
Sheepskin	Sheepskin naturel	961821MW01	961821MU01
	H bull calf leather noir ébène	960359MW01	960359MU01
	H bull calf leather ivoire	960359MW02	960359MU02
H bull calf leather	H bull calf leather étoupe	960359MW03	960359MU03
	H bull calf leather ébène	960359MW04	960359MU04
	H bull calf leather gold	960359MW05	960359MU05
	H bull calf leather fauve	960359MW06	960359MU06
Smooth calfskin	Smooth calfskin ivoire	960247MW02	960247MU02
	Smooth calfskin étoupe	960247MW03	960247MU03
	Smooth calfskin ébène	960247MW04	960247MU04
	Smooth calfskin gold	960247MW05	960247MU05

## Care advice

- For the piece to retain its quality over time, it should be cleaned with a soft cloth and any spills should be wiped off immediately using a clean, absorbent cloth.
- To take care of sheepskin finish, vacuum with a soft brush once a month to remove dust. Blot any stains with white paper towels as quickly as possible
- If you have any other queries about furniture care, please contact Hermès Customer Service.

## Packing information

1 package with a total weight of 305 kg.  
Package size: 246x112x104 cm  
(96<sup>7/8</sup> x 44<sup>1/16</sup> x 40<sup>15/16</sup> in).

# Bench in wrought-iron and leather

Jean-Michel Frank furniture designs by Hermès

## Bench in wrought-iron and leather

Wrought-iron structure.  
Traditional upholstery. Seat, back and armrests in bridle leather.

Designer: Re-edition in partnership with the Frank family and the Jean-Michel Frank Committee, faithful to the original work.  
Made in France

+ Very pared-back, minimalist lines, true to the designer's style.



Bench, wrought-iron and fauve bridle leather

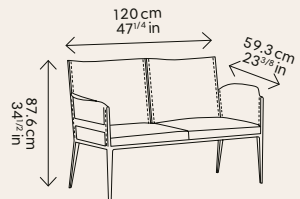

H seat base: 43 cm / 16<sup>7</sup>/<sub>8</sub> in  
H armrest: 60 cm / 23<sup>5</sup>/<sub>8</sub> in

# Bench in wrought-iron and leather

Jean-Michel Frank furniture designs by Hermès



## Reference

LEATHER	FINISH	Worldwide except USA	USA
Bridle leather	Wrought-iron	960396MW01	960396MU01

## Important to know

Exceptional leathercraft – saddle-stitching, polishing, waxing, lacing – combined with highly skilled blacksmithing involving red hot, hammered, waxed and brushed iron.

## Care advice

- For the piece to retain its quality over time, it should be cleaned with a soft cloth and any spills should be wiped off immediately using a clean, absorbent cloth.
- If you have any other queries about furniture care, please contact Hermès Customer Service.

## Packing information

1 package with a total weight of 130 kg.  
Package size: 136 x 78 x 112 cm  
(53<sup>9/16</sup> x 30<sup>11/16</sup> x 44<sup>1/16</sup> in).



# Armchair & console in wrought-iron and leather

Jean-Michel Frank furniture designs by Hermès

## Armchair

Wrought-iron structure.  
Traditional upholstery. Seat, back  
and armrests in bridle leather.

## Console

Wrought-iron structure.  
Wooden tabletop covered  
in bridle leather.

Designer: Re-edition in partnership  
with the Frank family  
and the Jean-Michel Frank Committee,  
faithful to the original work.  
Made in France

+ Very pared-back, minimalist lines,  
true to the designer's style.



Armchair, wrought-iron and fauve bridle leather



Console, wrought-iron and fauve bridle leather

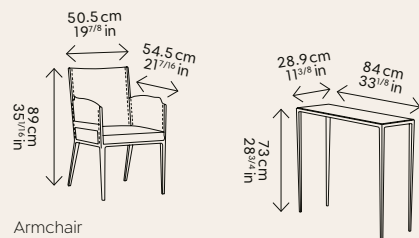

Armchair  
H armrest: 60 cm / 23<sup>5/8</sup> in  
H seat base: 43 cm / 24<sup>3/4</sup> in

# Armchair & console in wrought-iron and leather

Jean-Michel Frank furniture designs by Hermès



## References

		Armchair		Console
LEATHER	FINISH	Worldwide except USA	USA	
Bridle leather	Wrought-iron	960399MW01	960399MU01	960010M 01

### Important to know

Exceptional leathercraft – saddle-stitching, polishing, waxing, lacing – combined with highly skilled blacksmithing involving red hot, hammered, waxed and brushed iron.

### Care advice

- For the piece to retain its quality over time, it should be cleaned with a soft cloth and any spills should be wiped off immediately using a clean, absorbent cloth.
- If you have any other queries about furniture care, please contact Hermès Customer Service.

### Packing information

- Armchair in wrought-iron and leather:  
1 package with a total weight of 87kg.  
Package size: 74x74x114 cm  
(29<sup>1/8</sup>x29<sup>1/8</sup>x44<sup>7/8</sup> in).
- Console table in wrought-iron and leather:  
1 package with a total weight of 56.5kg.  
Package size: 100x90x54 cm  
(39<sup>3/8</sup>x35<sup>7/16</sup>x21<sup>1/4</sup> in).

# Chair

Jean-Michel Frank furniture designs by Hermès

## Chair

Traditional upholstery.  
Padded seat upholstered in leather  
(smooth calfskin, H bull calf).

Designer: Re-edition in partnership  
with the Frank family  
and the Jean-Michel Frank Committee,  
faithful to the original work.  
Made in Italy



Chair with padded seat, oak with natural ceruse finish,  
fauve H bull calf leather, 960360M 06



Chair with padded seat and armrests, oak with brown ceruse finish,  
noir ébène H bull calf leather, 960363M 01

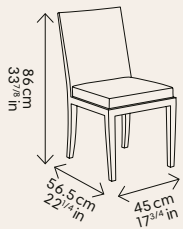

Chair  
H seat base: 46 cm / 18 1/8 in

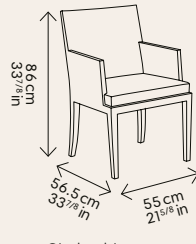

Chair with armrests  
H seat base: 46 cm / 18 1/8 in  
H armrest: 64.5 cm / 25 3/8 in



# Chair

Jean-Michel Frank furniture designs by Hermès



Chair with padded seat, oak with natural ceruse finish, fauve H bull calf leather



Chair with padded seat and armrests, oak with natural ceruse finish, ivoire H bull calf leather



Chair with padded seat, oak with brown ceruse finish, noir ébène H bull calf leather



Chair with padded seat and armrests, oak with brown ceruse finish, noir H bull calf leather

## Finishes

### Ceruse-finished oak

naturel brun

### Ceruse-finished oak

naturel brun

### H bull calf leather

noir ébène ivoire étoupe ébène gold fauve

### Smooth calfskin

ivoire étoupe ébène gold

# Chair

## Jean-Michel Frank furniture designs by Hermès

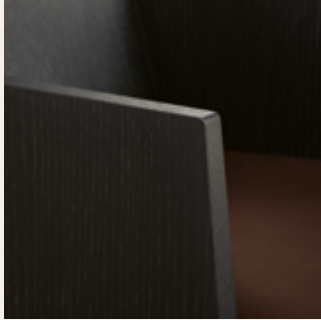

### Important to know

Solid oak frame with natural ceruse finish and leather glides.



### Care advice

- For the piece to retain its quality over time, it should be cleaned with a soft cloth and any spills should be wiped off immediately using a clean, absorbent cloth.
- If you have any other queries about furniture care, please contact Hermès Customer Service.

### Packing information

- Chair without armrests: 41 kg.  
71 x 60 x 108 cm  
(27<sup>15/16</sup> x 23<sup>5/8</sup> x 42<sup>1/2</sup> in).
- Chair with armrests: 48 kg.  
71 x 60 x 108 cm  
(27<sup>15/16</sup> x 23<sup>5/8</sup> x 42<sup>1/2</sup> in).

### References

WOOD	FINISH				
		Worldwide except USA	USA	Worldwide except USA	USA
Natural ceruse-finished oak	H bull calf leather noir ébène	960360MW01	960360MU01	960361MW01	960361MU01
	H bull calf leather ivoire	960360MW02	960360MU02	960361MW02	960361MU02
	H bull calf leather étoupe	960360MW03	960360MU03	960361MW03	960361MU03
	H bull calf leather ébène	960360MW04	960360MU04	960361MW04	960361MU04
	H bull calf leather gold	960360MW05	960360MU05	960361MW05	960361MU05
	H bull calf leather fauve	960360MW06	960360MU06	960361MW06	960361MU06
	Smooth calfskin ivoire	960248MW02	960248MU02	960250MW02	960250MU02
	Smooth calfskin étoupe	960248MW03	960248MU03	960250MW03	960250MU03
	Smooth calfskin ébène	960248MW04	960248MU04	960250MW04	960250MU04
	Smooth calfskin gold	960248MW05	960248MU05	960250MW05	960250MU05
Brown ceruse-finished oak	H bull calf leather noir ébène	960362MW01	960362MU01	960363MW01	960363MU01
	H bull calf leather ivoire	960362MW02	960362MU02	960363MW02	960363MU02
	H bull calf leather étoupe	960362MW03	960362MU03	960363MW03	960363MU03
	H bull calf leather ébène	960362MW04	960362MU04	960363MW04	960363MU04
	H bull calf leather gold	960362MW05	960362MU05	960363MW05	960363MU05
	H bull calf leather fauve	960362MW06	960362MU06	960363MW06	960363MU06
	Smooth calfskin ivoire	960249MW02	960249MU02	960251MW02	960251MU02
	Smooth calfskin étoupe	960249MW03	960249MU03	960251MW03	960251MU03
	Smooth calfskin ébène	960249MW04	960249MU04	960251MW04	960251MU04
	Smooth calfskin gold	960249MW05	960249MU05	960251MW05	960251MU05

# Table X

## Jean-Michel Frank furniture designs by Hermès

### Table

Tabletop veneered in oak  
Apron and legs in solid wood  
(ceruse-finished oak).  
Stretcher in iron with surface patina.

Designer: Re-edition in partnership  
with the Frank family  
and the Jean-Michel Frank Committee,  
faithful to the original work.  
Made in Italy

+ The table draws its name from  
its X-shaped frame.

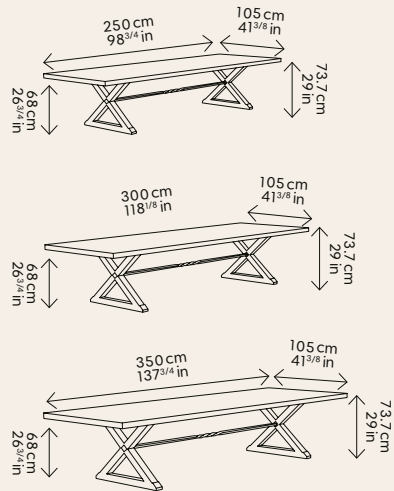

X table, 250 cm, oak with natural ceruse finish, 910102M 01



X table, 250 cm, oak with brown ceruse finish, 910102M 02

### Finishes

#### Ceruse-finished oak

naturel brun

# Table X

## Jean-Michel Frank furniture designs by Hermès



### References

FINISH	TABLE 250	TABLE 300	TABLE 350
Natural ceruse-finished oak	910102M 01	910103M 01	910104M 01
Brown ceruse-finished oak	910102M 02	910103M 02	910104M 02

### Care advice

- For the piece to retain its quality over time, it should be cleaned with a soft cloth and any spills should be wiped off immediately using a clean, absorbent cloth.
- If you have any other queries about furniture care, please contact Hermès Customer Service.

### Packing information

- Table 250:
  - 1 package with a total weight of 167 kg.  
Package size: 267x132x34.5 cm (105<sup>1/8</sup>x52x13<sup>9/16</sup> in).
  - 1 package with a total weight of 44.5 kg.  
Package size: 94x82x40 cm (37x32<sup>1/4</sup>x15<sup>3/4</sup> in).
- Table 300:
  - 1 package with a total weight of 171.5 kg.  
Package size: 316x132x34.5 cm (124<sup>7/16</sup>x52x13<sup>9/16</sup> in).
  - 1 package with a total weight of 45.5 kg.  
Package size: 94x82x40 cm (37x32<sup>1/4</sup>x15<sup>3/4</sup> in).
- Table 350:
  - 1 package with a total weight of 225 kg.  
Package size: 365x132x34.5 cm (143<sup>11/16</sup>x52x13<sup>9/16</sup> in).
  - 1 package with a total weight of 44.5 kg.  
Package size: 94x82x40 cm (37x32<sup>1/4</sup>x15<sup>3/4</sup> in).

# Soleil round coffee table

## Jean-Michel Frank furniture designs by Hermès

### Soleil round coffee table

Waxed natural rye straw marquetry  
"Sun" pattern on the tabletop.  
Underside in varnished sycamore.

Designer: Re-edition in partnership  
with the Frank family  
and the Jean-Michel Frank Committee,  
faithful to the original work.  
Made in France

+ These designs reflect the Art Déco  
movement, showcasing a material  
that Jean-Michel Frank had  
a high regard for and which was  
rediscovered in the 1930s.



**Small model**, straw marquetry, 910039M 01, temporarily unavailable for USA importation



**Large model**, straw marquetry, 910038M 01, temporarily unavailable for USA importation

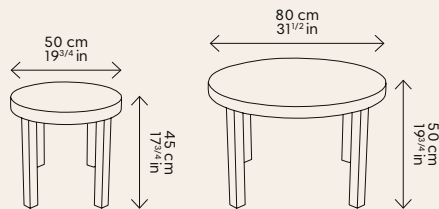

### Care advice

- For the piece to retain its quality over time, it should be cleaned with a soft cloth and any spills should be wiped off immediately using a clean, absorbent cloth.
- If you have any other queries about furniture care, please contact Hermès Customer Service.

### Packing information

- Small round Soleil coffee table:  
1 package with a total weight of 35 kg.  
Package size: 56 x 56 x 51 cm  
(22<sup>1/16</sup> x 22<sup>1/16</sup> x 20<sup>1/16</sup> in).

- Large round Soleil coffee table:  
1 package with a total weight of 54 kg.  
Package size: 86 x 86 x 56 cm  
(33<sup>7/8</sup> x 33<sup>7/8</sup> x 22<sup>1/16</sup> in).

# Cupboard of secrets

## Jean-Michel Frank furniture designs by Hermès

### Nest of boxes

Nest of boxes in waxed natural rye straw marquetry.  
Patterns: "straight straw" on the sides, "sun" on the three horizontal surfaces.

Designer: Re-edition in partnership with the Frank family and the Jean-Michel Frank Committee, faithful to the original work.  
Made in France

- + These designs reflect the Art Déco movement, showcasing a material that Jean-Michel Frank had a high regard for and which was rediscovered in the 1930s.

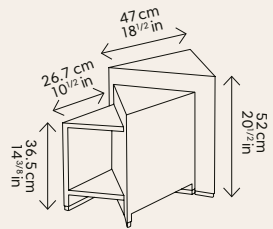

Closed L 47 x H 52 cm  
L 18 1/2 x H 20 1/2 in

Deployed L 74 x D 47 x H 52 cm  
L 29 1/8 x D 18 1/2 x H 20 1/2 in



Closed nest of boxes, straw marquetry, 910122M 01, temporarily unavailable for USA importation



Open nest of boxes, straw marquetry

### Care advice

- For the piece to retain its quality over time, it should be cleaned with a soft cloth and any spills should be wiped off immediately using a clean, absorbent cloth.
- If you have any other queries about furniture care, please contact Hermès Customer Service.

### Packing information

- 1 package with a total weight of 38 kg.  
Package size: 65 x 65 x 60 cm  
(25 9/16 x 25 9/16 x 23 5/8 in).

# Folding screen

## Jean-Michel Frank furniture designs by Hermès

### Folding screen

Waxed natural rye straw marquetry.  
Patterns: recto "straight straw",  
verso "sun"

Designer: Re-edition in partnership  
with the Frank family  
and the Jean-Michel Frank Committee,  
faithful to the original work.  
Made in France

+ These designs reflect the Art Déco  
movement, showcasing a material  
that Jean-Michel Frank had  
a high regard for and which was  
rediscovered in the 1930s.

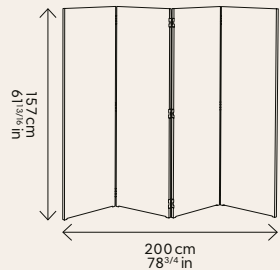

Open	Closed
L 200 x D 3 x H 157cm	L 50 x D 10.5 x H 157 cm
L 78 <sup>3/4</sup> x D 1 <sup>3/16</sup> x H 61 <sup>13/16</sup> in	L 19 <sup>3/4</sup> x D 4 <sup>1/8</sup> x H 61 <sup>3/16</sup> in



Folding screen, front "sun" pattern, straw marquetry, 910040M 01,  
temporarily unavailable for USA importation



Folding screen, back "straight straw" pattern, straw marquetry

### Care advice

- For the piece to retain its quality over time, it should be cleaned with a soft cloth and any spills should be wiped off immediately using a clean, absorbent cloth.
- If you have any other queries about furniture care, please contact Hermès Customer Service.

### Packing information

1 package with a total weight of 57 kg.  
Package size: 165 x 60 x 26 cm  
(64<sup>15/16</sup> x 23<sup>5/8</sup> x 10<sup>1/4</sup> in).

## CARPETS

Cordélie

## FURNITURE

Ancelle d'Hermès  
Atout d'Hermès  
Chaise Conservatoire  
Contour d'Hermès  
Équilibre d'Hermès  
Équipages d'Hermès  
Equis d'Hermès  
Hippodrome d'Hermès  
Karumi  
The Sellier Chair  
Les Nécessaires d'Hermès  
Les Trotteuses d'Hermès  
Lignage d'Hermès  
Métiers  
Oria d'Hermès  
Persiennes  
Pippa  
Jean-Michel Frank furniture  
designs by Hermès  
**Sillage d'Hermès**  
Sofa Sellier  
Tray-Tôt

## LIGHTING

Coulisse  
Halo  
Hécate  
Harnais  
Lanterne d'Hermès  
Pantographe  
Sarazine

# Sillage d'Hermès

This organically shaped seat is inspired by far away places. Its generous proportions have been designed by architects at Studio Mumbai. Its structure is composed of wood, while its coating is a unique compound containing cellulose microfibers made in Puglia, Italy, the 16th century-birthplace of papier mâché. Striking the perfect balance between material innovation and ancestral know-how, this robust yet sensual totem armchair – varnished and hand-painted one line after the other – creates an intimate relationship with the material.

Designer Studio Mumbai, Indian architecture and design studio



# Armchair Sillage d'Hermès

## Armchair

Beechwood structure clad in cellulose microfibrils in the style of papier mâché, with hand-painted decoration. The microfibre compound is vegetable dyed and shaped by hand. Seat and back cushions in hand-spun and hand-woven cashmere.

Designer: Mumbai Studio  
Made in Italy

- + The generous proportions of this seat, with its organic shape and far-flung origins, were designed by Studio Mumbai.



Armchair, hand-painted *papier mâché*, hand-woven cashmere cushions, 960236M 01

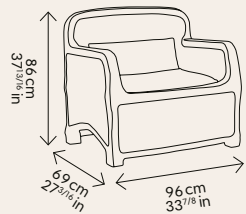

D base seat: around 45 cm / around 17<sup>3</sup>/<sub>4</sub> in  
H base seat: 40.2 cm / 15<sup>7</sup>/<sub>8</sub> in  
H armrest: 66.3 cm / 26<sup>1</sup>/<sub>8</sub> in

# Armchair Sillage d'Hermès



## Reference

<b>MATERIAL</b>	Armchair
Papier Mâché	960236M 01

### Important to know

- Varnished and hand-painted line by line.
- Papier-mâché is very vulnerable to knocks, scratches and acids.

### Care advice

- Wiping down the surfaces of the armchair with a soft, dry cloth is the only daily maintenance required. If the stain persists, do not hesitate to contact your Hermès store.
- We recommend that you avoid using abrasive or corrosive products. Papier-mâché is a fragile material, vulnerable to variations in humidity and temperature: avoid exposing it to heat, humidity or bright light, which could alter its colour and cause it to develop tiny cracks. It is also likely to be damaged by hard knocks or objects with sharp edges, such as the rivets on jeans.

### Packing information

1 package with a total weight of 90 kg.  
Package size: 112 x 86 x 110 cm  
(44<sup>1/16</sup> x 33<sup>7/8</sup> x 43<sup>5/16</sup> in).

## CARPETS

Cordélie

## FURNITURE

Ancelle d'Hermès  
Atout d'Hermès  
Chaise Conservatoire  
Contour d'Hermès  
Équilibre d'Hermès  
Équipages d'Hermès  
Equis d'Hermès  
Hippodrome d'Hermès  
Karumi  
The Sellier Chair  
Les Nécessaires d'Hermès  
Les Trotteuses d'Hermès  
Lignage d'Hermès  
Métiers  
Oria d'Hermès  
Persiennes  
Pippa  
Jean-Michel Frank furniture  
designs by Hermès  
Sillage d'Hermès  
**Sofa Sellier**  
Tray-Tôt

## LIGHTING

Coulisse  
Halo  
Hécate  
Harnais  
Lanterne d'Hermès  
Pantographe  
Sarazine

# Sofa Sellier

The association of Hermès the saddle-maker and furniture goes back to 1924, when French interior designer Jean-Michel Frank called on the house to create sleek leather coverings for sofas and chairs. Continuing this narrative, the Sellier sofa makes more than one reference to the house's equestrian heritage in an archetypal, modular piece whose design is led by a quest for ingenuity and surprises that delight as they reveal themselves. Materials and métiers come together: the cabinetmaking, the upholstery, and caning. Within the harmony there are surprising cadences: like the interior of a carriage, this sofa has hidden pockets and compartments designed for the ease and pleasure of its owner; the saddlebags on the side of the armrest include pockets for magazines and the caned screen shelters a leather-covered box of secrets.

Designer Noé Duchaufour-Lawrence, French designer

# Armchair Sofa Sellier

## Armchair

Structure in Canaletto walnut.  
Seat and cushions in toile flammée  
and H bull calf leather.  
Caned screen armrests.

Designer: Noé Duchaufour-Lawrance  
Made in Italy

- + This wicker weave armchair draws inspiration from our equestrian heritage.



**Armchair**, Canaletto walnut, fauve H bull calf leather, cannelle Toile flammée, canework, 960332M 01

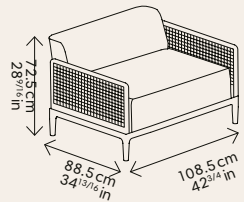

D base seat: 64 cm / 25<sup>1/4</sup> in  
H base seat: 46.5 cm / 18<sup>5/16</sup> in  
H armrest: 60 cm / 23<sup>5/8</sup> in

# Armchair Sofa Sellier



**Leather and fabric version,** Canaletto walnut, fauve H bull calf leather, cannelle Toile flammée, canework



**Leather version,** Canaletto walnut, fauve H bull calf leather, cannelle Toile flammée, canework

## Finishes

Canaletto walnut

H bull calf leather / Toile flammée

H bull calf leather

fauve / cannelle   étoupe / gris ponce   noir ébène / ébène   chocolat / ébène

fauve   étoupe   noir ébène   chocolat

# Armchair Sofa Sellier



## References

WOOD	FINISH	Worldwide except USA	USA
Canaletto walnut	H bull calf leather fauve / toile flammée cannelle	960332MW01	960332MU01
	H bull calf leather étoupe / toile flammée gris ponce	960332MW02	960332MU02
	H bull calf leather noir ébène / toile flammée ébène	960332MW03	960332MU03
	H bull calf leather chocolat / toile flammée ébène	960332MW04	960332MU04
	H bull calf leather fauve	960331MW01	960331MU01
	H bull calf leather étoupe	960331MW02	960331MU02
	H bull calf leather noir ébène	960331MW03	960331MU03
	H bull calf leather chocolat	960331MW04	960331MU04



### Important to know

- Wicker woven by hand. In order to produce a perfectly smooth finish on the wickerwork, some strands are burned off and this causes slightly black marks.
- Internal structure of the seat cushions: metal springs and goose feather down filling.
- If the cushion appears to flatten over time, simply

plump it up a bit so the feather filling expands again.

### Care advice

- For the piece to retain its quality over time, it should be cleaned with a soft cloth and any spills should be wiped off immediately using a clean, absorbent cloth.
- If you have any other queries about furniture care, please contact Hermès Customer Service.

### Packing information

1 package with a total weight of 119kg.  
 Package size: 130x105x93cm  
 (51<sup>3/16</sup>x41<sup>5/16</sup>x36<sup>5/8</sup> in).

## 2-seater sofa Sofa Sellier

### 2-seater sofa

Traditional upholstery.  
Structure in Canaletto walnut.  
Seat and cushions in toile flammée  
and H bull calf leather.  
Saddle bag in H bull calf leather  
on the leather armrest. Caned screen  
on the left-hand side when seated,  
with storage box covered in H bull calf  
leather and electricity cable access.

Designer: Noé Duchaufour-Lawrance  
Made in Italy

+ Just like the inside of a horse-drawn carriage, this contemporary sofa offers unexpected details – like concealed pockets and compartments that combine convenience with aesthetic pleasure.



2-leather armrest, saddle bag on the right armrest when seated version, Canaletto walnut, fauve H bull calf leather, cannelle Toile flammée, canework, 960299M 01



Caned screen on the right-hand side when seated version, saddle bag on the armrest, Canaletto walnut, fauve H bull calf leather, cannelle Toile flammée, 960302M 01



Caned screen on the left-hand side when seated version, saddle bag on the armrest, Canaletto walnut, fauve H bull calf leather, cannelle Toile flammée, 960023M 01

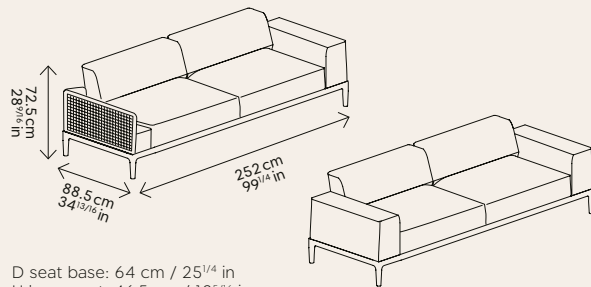

D seat base: 64 cm / 25 1/4 in  
H base seat: 46.5 cm / 18 5/16 in  
H armrest: 60 cm / 23 5/8 in

## 2-seater sofa Sofa Sellier



**Leather and fabric version**, 2-leather armrest, saddle bag on the right armrest when seated version, Canaletto walnut, fauve H bull calf leather, cannelle Toile flammée



**All-leather version**, caned screen on the right-hand side when seated, saddle bag on the armrest, Canaletto walnut, fauve H bull calf leather, cannelle Toile flammée

### Finishes

Canaletto walnut

H bull calf leather / Toile flammée

H bull calf leather

fauve / cannelle   étoupe / gris ponce   chocolat / ébène   noir ébène / ébène

fauve   étoupe   noir ébène   chocolat



# 2-seater sofa Sofa Sellier

## References

WOOD	FINISH	CANED SCREEN ON THE LEFT-HAND WHEN SEATED, SADDLE BAG ON THE RIGHT		CANED SCREEN ON THE RIGHT-HAND WHEN SEATED, SADDLE BAG ON THE LEFT		NO CANED SCREEN, SADDLE BAG ON THE LEFT-HAND WHEN SEATED		NO CANED SCREEN, SADDLE BAG ON THE RIGHT-HAND WHEN SEATED	
		Worldwide except USA	USA	Worldwide except USA	USA	Worldwide except USA	USA	Worldwide except USA	USA
Canaletto walnut	H bull calf leather fauve / toile flammée cannelle	960301MW01	960301MU01	960302MW01	960302MU01	960300MW01	960300MU01	960299MW01	960299MU01
	H bull calf leather étoupe / toile flammée gris ponce	960301MW02	960301MU02	960302MW02	960302MU02	960300MW02	960300MU02	960299MW02	960299MU02
	H bull calf leather noir ébène / toile flammée ébène	960301MW03	960301MU03	960302MW03	960302MU03	960300MW03	960300MU03	960299MW03	960299MU03
	H bull calf leather chocolat / toile flammée ébène	960301MW04	960301MU04	960302MW04	960302MU04	960300MW04	960300MU04	960299MW04	960299MU04
	H bull calf leather fauve	960317MW01	960317MU01	960318MW01	960318MU01	960316MW01	960316MU01	960315MW01	960315MU01
	H bull calf leather étoupe	960317MW02	960317MU02	960318MW02	960318MU02	960316MW02	960316MU02	960315MW02	960315MU02
	H bull calf leather noir ébène	960317MW03	960317MU03	960318MW03	960318MU03	960316MW03	960316MU03	960315MW03	960315MU03
	H bull calf leather chocolat	960317MW04	960317MU04	960318MW04	960318MU04	960316MW04	960316MU04	960315MW04	960315MU04



### Important to know

- Wicker woven by hand. In order to produce a perfectly smooth finish on the wickerwork, some strands are burned off and this causes slightly black marks.
- Internal structure of the seat cushions: metal springs and goose feather down filling.
- If the cushion appears to flatten over time, simply plump it up a bit so the feather filling expands again.

### Care advice

- For the piece to retain its quality over time, it should be cleaned with a soft cloth and any spills should be wiped off immediately using a clean, absorbent cloth.
- If you have any other queries about furniture care, please contact Hermès Customer Service.

### Packing information

4 boxes:

- 1 package with a total weight of 145 kg. Package size: 262x92x42 cm (103<sup>1/8</sup> x 36<sup>1/4</sup> x 16<sup>9/16</sup> in).
- 1 package with a total weight of 83 kg. Package size: 113x108x78 cm (44<sup>1/2</sup> x 42<sup>1/2</sup> x 30<sup>11/16</sup> in).
- 1 package with a total weight of 82 kg. Package size: 104x115x77 cm (40<sup>15/16</sup> x 45<sup>1/4</sup> x 30<sup>5/16</sup> in).

## 2-seater sofa with chaise lounge Sofa Sellier

### 2-seater sofa with chaise lounge

Traditional upholstery.  
Structure in Canaletto walnut.  
Seat and cushions in toile flammée  
and H bull calf leather.  
Saddle bag in H bull calf leather  
on the leather armrest. Caned screen  
on the left-hand side when seated,  
with storage box covered in H bull calf  
leather and electricity cable access.

Designer: Noé Duchaufour-Lawrance  
Made in Italy

+ Just like the inside of a horse-drawn carriage, this contemporary sofa offers unexpected details – like concealed pockets and compartments that combine convenience with aesthetic pleasure.

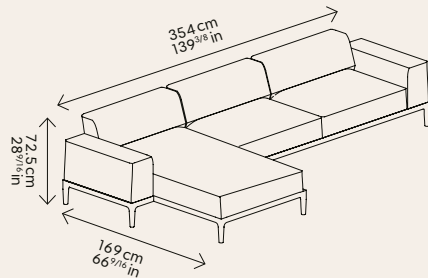

D seat base: 64 cm / 25 1/4 in  
H base seat: 46.5 cm / 18 5/16 in  
H armrest: 60 cm / 23 5/8 in



Chaise lounge on the right-hand side when seated, 2 leather armrests, saddle bag on the chaise lounge armrest version, Canaletto walnut, noir ébène H bull calf leather, ébène Toile flammée, 960303M 03



Chaise lounge on the left-hand when seated, 2 leather armrests, saddle bag on the chaise lounge armrest version, Canaletto walnut, noir ébène H bull calf leather, ébène Toile flammée, 960304M 03



Chaise lounge on the right-hand side when seated, caned screen on the left-hand side, saddle bag on the armrest version, Canaletto walnut, noir ébène H bull calf leather, ébène Toile flammée, 960305M 03



Chaise lounge on the left-hand when seated, caned screen on the right-hand side, saddle bag on the armrest version, Canaletto walnut, noir ébène H bull calf leather, ébène Toile flammée, 960306M 03

## 2-seater sofa with chaise lounge Sofa Sellier



**Leather and fabric version**, chaise lounge on the right-hand side when seated, caned screen on the left-hand side, saddle bag on the armrest version, Canaletto walnut, noir ébène H bull calf leather, ébène Toile flammée



**All-leather version**, chaise lounge on the right-hand side when seated, caned screen on the left-hand side, saddle bag on the armrest version, Canaletto walnut, noir ébène H bull calf leather, ébène Toile flammée

### Finishes

Canaletto walnut

H bull calf leather / Toile flammée

H bull calf leather

fauve / cannelle   étoupe / gris ponce   chocolat / ébène   noir ébène / ébène

fauve   étoupe   noir ébène   chocolat

# 2-seater sofa with chaise lounge Sofa Sellier

## References

WOOD	FINISH	CHAISE LOUNGE ON THE RIGHT-HAND WHEN SEATED, CANED SCREEN ON THE LEFT-HAND		CHAISE LOUNGE ON THE LEFT-HAND WHEN SEATED, CANED SCREEN ON THE RIGHT-HAND		CHAISE LOUNGE ON THE RIGHT-HAND WHEN SEATED, NO CANED SCREEN		CHAISE LOUNGE ON THE LEFT-HAND WHEN SEATED, NO CANED SCREEN	
		Worldwide except USA	USA	Worldwide except USA	USA	Worldwide except USA	USA	Worldwide except USA	USA
Canaletto walnut	H bull calf leather fauve / toile flammée cannelle	960305MW01	960305MU01	960306MW01	960306MU01	960303MW01	960303MU01	960304MW01	960304MU01
	H bull calf leather étoupe / toile flammée gris ponce	960305MW02	960305MU02	960306MW02	960306MU02	960303MW02	960303MU02	960304MW02	960304MU02
	H bull calf leather noir ébène / toile flammée ébène	960305MW03	960305MU03	960306MW03	960306MU03	960303MW03	960303MU03	960304MW03	960304MU03
	H bull calf leather chocolat / toile flammée ébène	960305MW04	960305MU04	960306MW04	960306MU04	960303MW04	960303MU04	960304MW04	960304MU04
	H bull calf leather fauve	960321MW01	960321MU01	960322MW01	960322MU01	960319MW01	960319MU01	960320MW01	960320MU01
	H bull calf leather étoupe	960321MW02	960321MU02	960322MW02	960322MU02	960319MW02	960319MU02	960320MW02	960320MU02
	H bull calf leather noir ébène	960321MW03	960321MU03	960322MW03	960322MU03	960319MW03	960319MU03	960320MW03	960320MU03
	H bull calf leather chocolat	960321MW04	960321MU04	960322MW04	960322MU04	960319MW04	960319MU04	960320MW04	960320MU04



### Important to know

- The saddle bag is always to be found on the armrest of the chaise lounge.
- Wicker woven by hand. In order to produce a perfectly smooth finish on the wickerwork, some strands are burned off and this causes slightly black marks.
- Internal structure of the seat cushions: metal springs and goose feather down filling.
- If the cushion appears to flatten over time, simply plump it up a bit so the feather filling expands again.

### Care advice

- For the piece to retain its quality over time, it should be cleaned with a soft cloth and any spills should be wiped off immediately using a clean, absorbent cloth.
- If you have any other queries about furniture care, please contact Hermès Customer Service.

### Packing information

- 6 packages:
- 1 package with a total weight of 100 kg. Package size: 240 x 95 x 42 cm (94<sup>1/2</sup> x 37<sup>3/8</sup> x 16<sup>9/16</sup> in).
  - 1 package with a total weight of 144 kg. Package size: 226.5 x 117.5 x 60.5 cm (89<sup>3/8</sup> x 46<sup>7/16</sup> x 24 in).
  - 1 package with a total weight of 80 kg. Package size: 104.5 x 100.5 x 68 cm (41<sup>5/16</sup> x 39<sup>3/4</sup> x 26<sup>3/4</sup> in).
  - 1 package with a total weight of 95 kg. Package size: 175.5 x 140 x 42 cm (69<sup>5/16</sup> x 55<sup>1/8</sup> x 16<sup>9/16</sup> in).
  - 1 package with a total weight of 94 kg. Package size: 116.5 x 105.5 x 77.5 cm (45<sup>11/16</sup> x 41<sup>5/16</sup> x 30<sup>5/16</sup> in).
  - 1 package with a total weight of 94 kg. Package size: 116.5 x 105.5 x 77.5 cm (45<sup>11/16</sup> x 41<sup>5/16</sup> x 30<sup>5/16</sup> in).

## 3-seater sofa Sofa Sellier

### 3-seater sofa

Traditional upholstery.  
Structure in Canaletto walnut.  
Seat and cushions in toile flammée  
and H bull calf leather.  
Saddle bag in H bull calf leather  
on the leather armrest. Caned screen  
on the left-hand side when seated,  
with storage box covered in H bull calf  
leather and electricity cable access.

Designer: Noé Duchaufour-Lawrance  
Made in Italy

+ Just like the inside of a horse-drawn carriage, this contemporary sofa offers unexpected details – like concealed pockets and compartments that combine convenience with aesthetic pleasure.



2-leather armrest, saddle bag on the right armrest when seated version, Canaletto walnut, chocolat H bull calf leather, ébène Toile flammée, 960307M 04



Caned screen on the right-hand side when seated and saddle bag on the armrest version, Canaletto walnut, chocolat H bull calf leather, ébène Toile flammée, 960310M 04



Caned screen on the left-hand side when seated and saddle bag on the armrest version, Canaletto walnut, chocolat H bull calf leather, ébène Toile flammée, 960309M 04

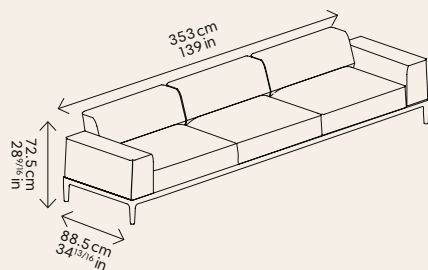

D seat base: 64 cm / 25<sup>1/4</sup> in  
H base seat: 46.5 cm / 18<sup>5/16</sup> in  
H armrest: 60 cm / 23<sup>5/8</sup> in

## 3-seater sofa Sofa Sellier



**Leather and fabric version**, caned screen on the right-hand side when seated and saddle bag on the armrest, Canaletto walnut, chocolat H bull calf leather, ébène Toile flammée



**All-leather version**, caned screen on the left-hand side when seated and saddle bag on the armrest, Canaletto walnut, chocolat H bull calf leather, ébène Toile flammée

### Finishes

Canaletto walnut

H bull calf leather / Toile flammée

H bull calf leather

fauve / cannelle   étoupe / gris ponce   chocolat / ébène   noir ébène / ébène

fauve   étoupe   noir ébène   chocolat

# 3-seater sofa Sofa Sellier

## References

WOOD	FINISH	CANED SCREEN ON THE LEFT-HAND WHEN SEATED, SADDLE BAG ON THE RIGHT		CANED SCREEN ON THE RIGHT-HAND WHEN SEATED, SADDLE BAG ON THE LEFT		NO CANED SCREEN, SADDLE BAG ON THE RIGHT-HAND WHEN SEATED		NO CANED SCREEN, SADDLE BAG ON THE LEFT-HAND WHEN SEATED	
		Worldwide except USA	USA	Worldwide except USA	USA	Worldwide except USA	USA	Worldwide except USA	USA
Canaletto walnut	H bull calf leather fauve / toile flammée cannelle	960309MW01	960309MU01	960310MW01	960310MU01	960307MW01	960307MU01	960308MW01	960308MU01
	H bull calf leather étoupe / toile flammée gris ponce	960309MW02	960309MU02	960310MW02	960310MU02	960307MW02	960307MU02	960308MW02	960308MU02
	H bull calf leather noir ébène / toile flammée ébène	960309MW03	960309MU03	960310MW03	960310MU03	960307MW03	960307MU03	960308MW03	960308MU03
	H bull calf leather chocolat / toile flammée ébène	960309MW04	960309MU04	960310MW04	960310MU04	960307MW04	960307MU04	960308MW04	960308MU04
	H bull calf leather fauve	960325MW01	960325MU01	960326MW01	960326MU01	960323MW01	960323MU01	960324MW01	960324MU01
	H bull calf leather étoupe	960325MW02	960325MU02	960326MW02	960326MU02	960323MW02	960323MU02	960324MW02	960324MU02
	H bull calf leather noir ébène	960325MW03	960325MU03	960326MW03	960326MU03	960323MW03	960323MU03	960324MW03	960324MU03
	H bull calf leather chocolat	960325MW04	960325MU04	960326MW04	960326MU04	960323MW04	960323MU04	960324MW04	960324MU04

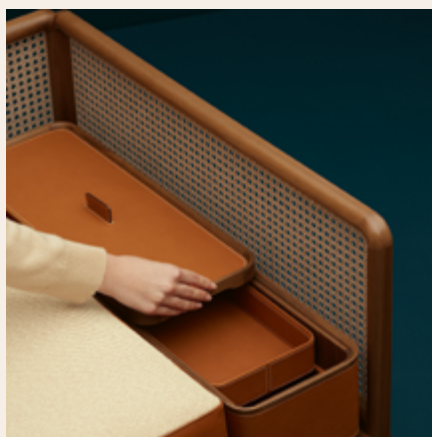

### Important to know

- Wicker woven by hand. In order to produce a perfectly smooth finish on the wickerwork, some strands are burned off and this causes slightly black marks.
- Internal structure of the seat cushions: metal springs and goose feather down filling.
- If the cushion appears to flatten over time, simply plump it up a bit so the feather filling expands again.

### Care advice

- For the piece to retain its quality over time, it should be cleaned with a soft cloth and any spills should be wiped off immediately using a clean, absorbent cloth.
- If you have any other queries about furniture care, please contact Hermès Customer Service.

### Packing information

- 5 packages:
- 1 package with a total weight of 155 kg. Package size: 361.5 x 92 x 42 cm (142<sup>1/8</sup> x 36<sup>1/4</sup> x 16<sup>9/16</sup> in).
  - 1 package with a total weight of 80 kg. Package size: 113 x 108 x 78 cm (44<sup>1/2</sup> x 42<sup>1/2</sup> x 30<sup>11/16</sup> in).
  - 1 package with a total weight of 80 kg. Package size: 113 x 108 x 78 cm (44<sup>1/2</sup> x 42<sup>1/2</sup> x 30<sup>11/16</sup> in).
  - 1 package with a total weight of 80 kg. Package size: 113 x 108 x 78 cm (44<sup>1/2</sup> x 42<sup>1/2</sup> x 30<sup>11/16</sup> in).
  - 1 package with a total weight of 80 kg. Package size: 110.5 x 102 x 75.5 cm (43<sup>5/16</sup> x 40<sup>3/16</sup> x 29<sup>1/2</sup> in).

# 5-seater sofa Sofa Sellier

## 5-seater sofa

Traditional upholstery.  
Structure in Canaletto walnut.  
Seat and cushions in toile flammée  
and H bull calf leather.  
Saddle bag in H bull calf leather  
on the leather armrest. Caned screen  
on the left-hand side when seated,  
with storage box covered in H bull calf  
leather and electricity cable access.

Designer: Noé Duchaufour-Lawrance  
Made in Italy

+ Just like the inside of a horse-drawn carriage, this contemporary sofa offers unexpected details – like concealed pockets and compartments that combine convenience with aesthetic pleasure.



2-leather armrest, saddle bag on the right armrest  
when seated version, Canaletto walnut, étoupe H bull  
calf leather, gris ponce Toile flammée,  
960311M 02



Caned screen on the right-hand side when seated  
version, saddle bag on the armrest, Canaletto walnut,  
étoupe H bull calf leather, gris ponce Toile flammée,  
960314M 02



Caned screen on the left-hand side when seated  
version, saddle bag on the armrest, Canaletto walnut,  
étoupe H bull calf leather, gris ponce Toile flammée,  
960313M 01

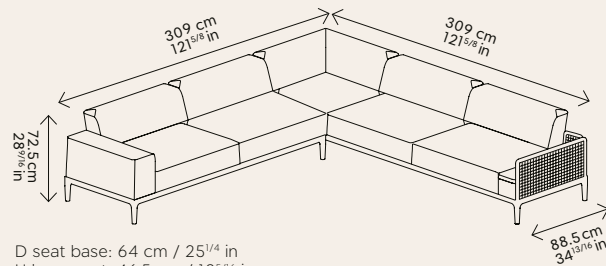

D seat base: 64 cm / 25<sup>1/4</sup> in  
H base seat: 46.5 cm / 18<sup>5/16</sup> in  
H armrest: 60 cm / 23<sup>5/8</sup> in



# 5-seater sofa Sofa Sellier



**Leather and fabric version**, caned screen on the left-hand side when seated version, saddle bag on the armrest, Canaletto walnut, étoupe H bull calf leather, gris ponce Toile flammée



**All-leather version**, caned screen on the right-hand side when seated, saddle bag on the armrest, Canaletto walnut, étoupe H bull calf leather, gris ponce Toile flammée

## Finishes

Canaletto walnut

H bull calf leather / Toile flammée

H bull calf leather

fauve / cannelle   étoupe / gris ponce   chocolat / ébène   noir ébène / ébène

fauve   étoupe   noir ébène   chocolat

# 5-seater sofa Sofa Sellier

## References

WOOD	FINISH	CANED SCREEN ON THE LEFT-HAND WHEN SEATED, SADDLE BAG ON THE RIGHT		CANED SCREEN ON THE RIGHT-HAND WHEN SEATED, SADDLE BAG ON THE LEFT		NO CANED SCREEN, SADDLE BAG ON THE RIGHT-HAND WHEN SEATED		NO CANED SCREEN, SADDLE BAG ON THE LEFT-HAND WHEN SEATED	
		Worldwide except USA	USA	Worldwide except USA	USA	Worldwide except USA	USA	Worldwide except USA	USA
Canaletto walnut	H bull calf leather fauve / toile flammée cannelle	960313MW01	960313MU01	960314MW01	960314MU01	960311MW01	960311MU01	960312MW01	960312MU01
	H bull calf leather étoupe / toile flammée gris ponce	960313MW02	960313MU02	960314MW02	960314MU02	960311MW02	960311MU02	960312MW02	960312MU02
	H bull calf leather noir ébène / toile flammée ébène	960313MW03	960313MU03	960314MW03	960314MU03	960311MW03	960311MU03	960312MW03	960312MU03
	H bull calf leather chocolat / toile flammée ébène	960313MW04	960313MU04	960314MW04	960314MU04	960311MW04	960311MU04	960312MW04	960312MU04
	H bull calf leather fauve	960329MW01	960329MU01	960330MW01	960330MU01	960327MW01	960327MU01	960328MW01	960328MU01
	H bull calf leather étoupe	960329MW02	960329MU02	960330MW02	960330MU02	960327MW02	960327MU02	960328MW02	960328MU02
	H bull calf leather noir ébène	960329MW03	960329MU03	960330MW03	960330MU03	960327MW03	960327MU03	960328MW03	960328MU03
	H bull calf leather chocolat	960329MW04	960329MU04	960330MW04	960330MU04	960327MW04	960327MU04	960328MW04	960328MU04



### Important to know

- Wicker woven by hand. In order to produce a perfectly smooth finish on the wickerwork, some strands are burned off and this causes slightly black marks.
- Internal structure of the seat cushions: metal springs and goose feather down filling.
- If the cushion appears to flatten over time, simply plump it up a bit so the feather filling expands again.

### Care advice

- For the piece to retain its quality over time, it should be cleaned with a soft cloth and any spills should be wiped off immediately using a clean, absorbent cloth.
- If you have any other queries about furniture care, please contact Hermès Customer Service.

### Packing information

- 8 packages:
- 1 package with a total weight of 84 kg. Package size: 104x115x77 cm (40<sup>15/16</sup>x45<sup>1/4</sup>x30<sup>5/16</sup> in).
  - 1 package with a total weight of 84 kg. Package size: 104x115x77 cm (40<sup>15/16</sup>x45<sup>1/4</sup>x30<sup>5/16</sup> in).
  - 1 package with a total weight of 84 kg. Package size: 104x115x77 cm (40<sup>15/16</sup>x45<sup>1/4</sup>x30<sup>5/16</sup> in).
  - 1 package with a total weight of 84 kg. Package size: 104x115x77 cm (40<sup>15/16</sup>x45<sup>1/4</sup>x30<sup>5/16</sup> in).
  - 1 package with a total weight of 142 kg. Package size: 323x92x42 cm (27<sup>3/16</sup>x36<sup>1/4</sup>x16<sup>9/16</sup> in).
- 1 package with a total weight of 78 kg. Package size: 104x110x67 cm (40<sup>5/16</sup>x43<sup>5/16</sup>x26<sup>3/8</sup> in).
  - 1 package with a total weight of 81 kg. Package size: 103x103x76 cm (40<sup>9/16</sup>x40<sup>9/16</sup>x29<sup>5/16</sup> in).
  - 1 package with a total weight of 106 kg. Package size: 123.5x92x41 cm (48<sup>7/16</sup>x36<sup>1/4</sup>x16<sup>1/8</sup> in).

## CARPETS

Cordélie

## FURNITURE

Ancelle d'Hermès  
Atout d'Hermès  
Chaise Conservatoire  
Contour d'Hermès  
Équilibre d'Hermès  
Équipages d'Hermès  
Equis d'Hermès  
Hippodrome d'Hermès  
Karumi  
The Sellier Chair  
Les Nécessaires d'Hermès  
Les Trotteuses d'Hermès  
Lignage d'Hermès  
Métiers  
Oria d'Hermès  
Persiennes  
Pippa  
Jean-Michel Frank furniture  
designs by Hermès  
Sillage d'Hermès  
Sofa Sellier  
**Tray-Tôt**

## LIGHTING

Coulisse  
Halo  
Hécate  
Harnais  
Lanterne d'Hermès  
Pantographe  
Sarazine

# Tray-Tôt

Lightweight accent piece which is easy to fold, move, carry around or to take to the porch with a coffee and a few cakes on the tray-top.

Designer Hermès Studio

# Tray holder Tray-Tôt

## Tray holder or occasional table

Tray and folding base in oak or Canaletto walnut.

Straps in bridle leather or hunter cowhide.

Handles in bridle leather affixed with metal saddle nails.

Designer: Hermès Studio  
Made in France

- + This piece gets its name from a play on the French word for trestles, "tréteaux" – the wooden (or metal) stands used to support a table or a stage. A small tweak to its spelling brought in the English word "tray", a reference to the upper part of the piece.



Natural oak and natural bridle leather version,  
960161M 01



Canaletto walnut and rouge H Hunter cowhide version,  
960187M 01

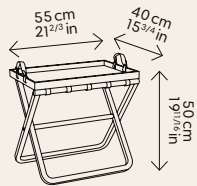

# Tray holder Tray-Tôt



## Reference

### WOOD

Natural oak

Canaletto walnut

### FINISH

Natural bridle leather

Rouge H Hunter cowhide

960161M 01

960187M 01

## Important to know

Cabinetwork detail: the frame and the tray's casing are assembled with sophisticated box jointing.

## Care advice

- For the piece to retain its quality over time, it should be cleaned with a soft cloth and any spills should be wiped off immediately using a clean, absorbent cloth.
- If you have any other queries about furniture care, please contact Hermès Customer Service.

## Packing information

1 package with a total weight of 27 kg.  
Package size: 70 x 66 x 30 cm  
(27<sup>9/16</sup> x 26 x 11<sup>13/16</sup> in).



## CARPETS

Cordélie

## FURNITURE

Ancelle d'Hermès  
Atout d'Hermès  
Chaise Conservatoire  
Contour d'Hermès  
Équilibre d'Hermès  
Équipages d'Hermès  
Equis d'Hermès  
Hippodrome d'Hermès  
Karumi  
The Sellier Chair  
Les Nécessaires d'Hermès  
Les Trotteuses d'Hermès  
Lignage d'Hermès  
Métiers  
Oria d'Hermès  
Persiennes  
Pippa  
Jean-Michel Frank furniture  
designs by Hermès  
Sillage d'Hermès  
Sofa Sellier  
Tray-Tôt

## LIGHTING

### Coulisse

Halo  
Hécate  
Harnais  
Lanterne d'Hermès  
Pantographe  
Sarazine

# Coulisse

To create these table lamps which combine sculpture and functionality, designer Tomàs Alonso assembles simple geometric shapes such as circles, rectangles, and triangles in an interplay of space and lightness. For this project, the Spanish designer took a craft-based design approach: an exceptionally light yet resistant bamboo frame/screen, a circle in copper-covered steel, and simple, visible technical components like stage lights painted in black come together to merge into the background and draw attention to the setting.

Designer Tomàs Alonso, Spanish designer

# Single-screen, T-shaped and Z-shaped models Coulisse

## Table lamp

Direct lighting and dimmer.  
Structure in bamboo covered  
with washi paper, connecting  
circle in copper-coated steel.

Designer: Tomàs Alonso  
Made in Japan

- + Compared to conventional papers, washi is a material that's much lighter, tougher and more supple. A special coating makes it even stronger and protects it against humidity.

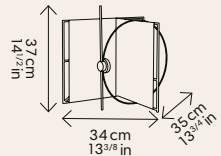
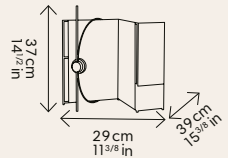
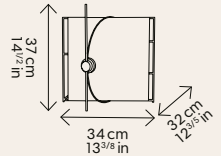

Light source: 6.2-W LED  
Colour temperature: 2,200°K  
Voltage: 110 - 240 V



Single-screen, 750410MW01



T-shaped, 750420MW01



Z-shaped, 750430MW01

# Single-screen, T-shaped and Z-shaped models Coulisse

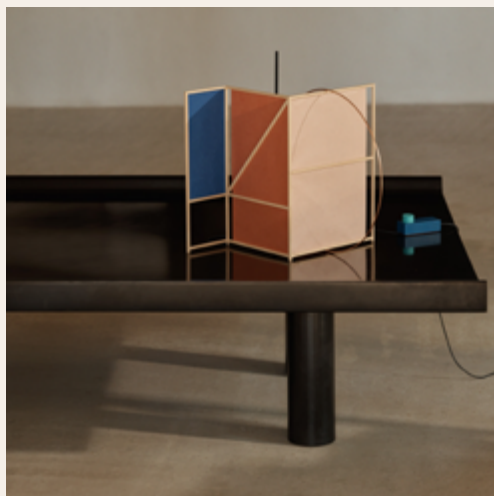
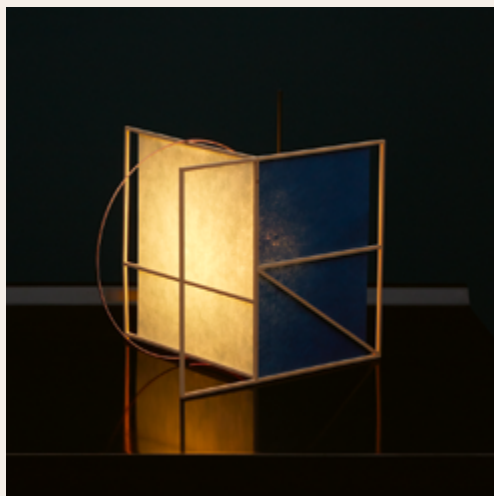

## References

	AUSTRALIA	CHINA	KOREA	USA & CANADA	EUROPE	UK & HK	JAPAN	SINGAPOUR	TAIWAN
Single-screen model	*	750410MW01	*	750410MW01	750410MW01	750410MW01	*	*	*
T-shaped model	*	750420MW01	*	750420MW01	750420MW01	750420MW01	*	*	*
Z-shaped model	*	750430MW01	*	750430MW01	750430MW01	750430MW01	*	*	*

\*No certification and import for this country.

### Important to know

The connecting cercle can move freely around the bamboo screen.

### Care advice

- Before cleaning any bulbs or lamps, make sure they are switched off and let them cool thoroughly to avoid any risk of burning yourself.
- For the lamp to retain its quality over time, it should be cleaned with a soft cloth and any spills should be wiped off immediately using a clean, absorbent cloth.
- If you have any queries about care or want to order parts (LED bulbs), please contact Hermès Customer Service.

### Packing information

The lamp is packaged in an orange box.



## CARPETS

Cordélie

## FURNITURE

Ancelle d'Hermès  
Atout d'Hermès  
Chaise Conservatoire  
Contour d'Hermès  
Équilibre d'Hermès  
Équipages d'Hermès  
Equis d'Hermès  
Hippodrome d'Hermès  
Karumi  
The Sellier Chair  
Les Nécessaires d'Hermès  
Les Trotteuses d'Hermès  
Lignage d'Hermès  
Métiers  
Oria d'Hermès  
Persiennes  
Pippa  
Jean-Michel Frank furniture  
designs by Hermès  
Sillage d'Hermès  
Sofa Sellier  
Tray-Tôt

## LIGHTING

Coulisse  
**Halo**  
Hécate  
Harnais  
Lanterne d'Hermès  
Pantographe  
Sarazine

# Halo

Creating the Halo table lamp in Limoges porcelain is a complicated endeavor for the artisans who must produce its lampshade by combining volume and perfect finesse. This object, designed by the British duo Edward Barber & Jay Osgerby, embodies a play on material and light. Its archetypal shape, combining rigour and purity, is livened up by a pumpkin leather cable clad.

Designers Barber & Osgerby, English designers

# Lamp Halo

## Table lamp

Diffuse lighting.  
Extra-white Limoges porcelain.  
Cable sheathed in pumpkin  
Velvet cowhide.

Designer: Barber & Osgerby  
Made in France

- + Halo brings to mind light and the sun. Creating the contours of this porcelain lamp is a very impressive technical achievement.



Porcelain, 750300M

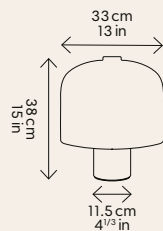

Light source: 13-W LED  
Colour temperature: 2,700 °K  
Voltage: 100 - 240 V

# Lamp Halo



## References

MATERIALS	AUSTRALIA	CHINA	EUROPE	JAPAN	KOREA	SINGAPOUR	TAIWAN	UK & HK	USA & CANADA
Porcelain	750300MW01	750300MW01	750300MW01	750300MJ01	*	750300MW01	750300MT01	750300MW01	750300MW01

\*No certification and import for this country..

## Care advice

- Before cleaning any bulbs or lamps, make sure they are switched off and let them cool thoroughly to avoid any risk of burning yourself.
- For the lamp to retain its quality over time, it should be cleaned with a soft cloth and any spills should be wiped off immediately using a clean, absorbent cloth.
- If you have any queries about care or want to order parts (LED bulbs), please contact Hermès Customer Service.

## Packing information

The lamp is packaged in an orange box.  
Size of the orange box: 72 x 39 x 33.5 cm.  
(28<sup>3</sup>/<sub>8</sub> x 15<sup>3</sup>/<sub>8</sub> x 13<sup>3</sup>/<sub>16</sub> in).  
Package size: 96 x 49 x 45 cm.  
(37<sup>13</sup>/<sub>16</sub> x 19<sup>5</sup>/<sub>16</sub> x 17<sup>3</sup>/<sub>4</sub> in).  
Weight of the package: 21 kg.

## CARPETS

Cordélie

## FURNITURE

Ancelle d'Hermès  
Atout d'Hermès  
Chaise Conservatoire  
Contour d'Hermès  
Équilibre d'Hermès  
Équipages d'Hermès  
Equis d'Hermès  
Hippodrome d'Hermès  
Karumi  
The Sellier Chair  
Les Nécessaires d'Hermès  
Les Trotteuses d'Hermès  
Lignage d'Hermès  
Métiers  
Oria d'Hermès  
Persiennes  
Pippa  
Jean-Michel Frank furniture  
designs by Hermès  
Sillage d'Hermès  
Sofa Sellier  
Tray-Tôt

## LIGHTING

Coulisse  
Halo  
**Hécate**  
Harnais  
Lanterne d'Hermès  
Pantographe  
Sarazine

# Hécate

Mineral and minimalist, the Hécate table lamp was created by British designers Edward Barber & Jay Osgerby. It takes its name from the goddess embodying the new moon, the black moon. Crafted from black granite, an exceptionally dense telluric material which requires the aid of diamond-tipped drills for it to be carved, this classically-shaped object absorbs light to let it only filter through a controlled circle. It is a highly studied piece whose pumpkin leather cable clad adds a touch of whimsy.

Designers Barber & Osgerby, English designers

# Lamp Hécate

## Table lamp

Black granite.  
Cable sheathed in pumpkin  
Velvet cowhide.

Designer: Barber & Osgerby  
Made in Italy

- + Hecate, the goddess of the moon in Greek mythology, symbolises mystery and the night.
- + Granite is twice as hard as marble, making it a material that is extremely complicated to work with. Its deep black colour means that it naturally absorbs light, giving a different and complementary approach to the Halo lamp in porcelain.

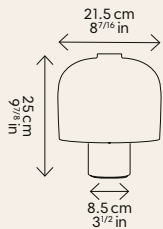

Light source: 6.2-W LED  
Colour temperature: 2,700 °K  
Voltage: 100 – 240 V



Black granite, 750301M



# Lamp Hécate



## References

MATERIALS	AUSTRALIA	CHINA	EUROPE	JAPAN	KOREA	SINGAPOUR	TAIWAN	UK & HK	USA & CANADA
Black granite	750301MW01	750301MW01	750301MW01	750301MJ01	*	750301MW01	750301MT01	750301MW01	750301MW01

\*No certification and import for this country.

## Care advice

- Before cleaning any bulbs or lamps, make sure they are switched off and let them cool thoroughly to avoid any risk of burning yourself.
- For the lamp to retain its quality over time, it should be cleaned with a soft cloth and any spills should be wiped off immediately using a clean, absorbent cloth.
- If you have any queries about care or want to order parts (LED bulbs), please contact Hermès Customer Service.

## Packing information

The lamp is packaged in an orange box.

## CARPETS

Cordélie

## FURNITURE

Ancelle d'Hermès  
Atout d'Hermès  
Chaise Conservatoire  
Contour d'Hermès  
Équilibre d'Hermès  
Équipages d'Hermès  
Equis d'Hermès  
Hippodrome d'Hermès  
Karumi  
The Sellier Chair  
Les Nécessaires d'Hermès  
Les Trotteuses d'Hermès  
Lignage d'Hermès  
Métiers  
Oria d'Hermès  
Persiennes  
Pippa  
Jean-Michel Frank furniture  
designs by Hermès  
Sillage d'Hermès  
Sofa Sellier  
Tray-Tôt

## LIGHTING

Coulisse  
Halo  
Hécate  
**Harnais**  
Lanterne d'Hermès  
Pantographe  
Sarazine

# Harnais

The name of this collection has not been chosen at random. Like the reins on a harness that connect horse and rider, those of the lamps in this collection connect the base to the shade. It is a marriage of saddle-stitched leather and opaline glass fixed with three "clou de selle" studs. The cables, which are completely hidden in leather sheathes, are the invisible testimony to finishing taken to the extreme. The sophistication of savoir-faire.

Designer Michele de Lucchi, Italian architect and designer

# Bedside lamp Harnais

## Bedside lamp

Direct and diffused light,  
dimmer switch.

Structure in nickel-plated steel  
Metallic branches covered  
in smooth bull calf leather,  
saddle-stitch finish.

Base in galvanised steel covered  
in leather.

Shade in opaline glass.

Covered cable and transformer  
protected by a leather sheath.

Designer: Michele de Lucchi

Made in Italy

- + Like the reins of a harness that connect a horse to its rider, those of the lamps in this collection connect the lamp shade to its base.
- + It is a marriage of saddle-stitched leather and opaline glass, fixed with three "clou de selle" studs.



Light source: 12-W LED  
Colour temperature: 2,700 °K  
Voltage: 100 - 240 V



Gold smooth bull calf, 750113MW01

## Finishes

### Smooth bull calf

gold

rouge H

étoupe

graphite



# Bedside lamp Harnais

## References

FINISH	AUSTRALIA	CHINA	EUROPE	JAPAN	KOREA	SINGAPOUR	TAIWAN	UK & HK	USA & CANADA
Smooth bull calf gold / Opaline glass	750113MW01	750113MW01	750113MW01	750113MW01	750113MK01	750113MW01	750113MW01	750113MW01	750113MW01
Smooth bull calf rouge H / Opaline glass	750113MW02	750113MW02	750113MW02	750113MW02	750113MK02	750113MW02	750113MW02	750113MW02	750113MW02
Smooth bull calf étoupe / Opaline glass	750113MW03	750113MW03	750113MW03	750113MW03	750113MK03	750113MW03	750113MW03	750113MW03	750113MW03
Smooth bull calf graphite / Opaline glass	750113MW04	750113MW04	750113MW04	750113MW04	750113MK04	750113MW04	750113MW04	750113MW04	750113MW04

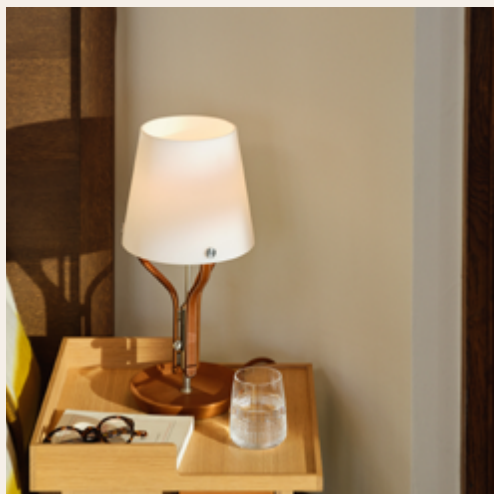

### Care advice

- Before cleaning any bulbs or lamps, make sure they are switched off and let them cool thoroughly to avoid any risk of burning yourself.
- For the lamp to retain its quality over time, it should be cleaned with a soft cloth and any spills should be wiped off immediately using a clean, absorbent cloth.
- If you have any queries about care or want to order parts (LED bulbs), please contact Hermès Customer Service.

### Packing information

The lamp is packaged in an orange box  
67 x 33 x 36 cm – 7kg  
(26<sup>3/8</sup> x 13 x 14<sup>3/16</sup> in).

# Table lamp Harnais

## Table lamp

Direct and diffused light,  
dimmer switch.

Structure in nickel-plated steel.

Metallic branches covered in smooth  
bull calf leather, saddle-stitch finish.

Base in galvanised steel covered  
in leather.

Shade in opaline glass.

Covered cable and transformer  
protected by a leather sheath.

Designer: Michele de Lucchi

Made in Italy

- + Like the reins of a harness that connect a horse to its rider, those of the lamps in this collection connect the lamp shade to its base.
- + It is a marriage of saddle-stitched leather and opaline glass, fixed with three "clou de selle" studs.



Light source: 18-W LED  
Colour temperature: 2,700 °K  
Voltage: 100 - 240 V



Rouge H smooth bull calf, 750112MW02

## Finishes

### Smooth bull calf

gold

rouge H

étoupe

graphite

# Table lamp Harnais

## References

FINISH	AUSTRALIA	CHINA	EUROPE	JAPAN	KOREA	SINGAPOUR	TAIWAN	UK & HK	USA & CANADA
Smooth bull calf gold / Opaline glass	750112MW01	750112MW01	750112MW01	750112MW01	750112MK01	750112MW01	750112MW01	750112MW01	750112MW01
Smooth bull calf rouge H / Opaline glass	750112MW02	750112MW02	750112MW02	750112MW02	750112MK02	750112MW02	750112MW02	750112MW02	750112MW02
Smooth bull calf étoupe / Opaline glass	750112MW03	750112MW03	750112MW03	750112MW03	750112MK03	750112MW03	750112MW03	750112MW03	750112MW03
Smooth bull calf graphite / Opaline glass	750112MW04	750112MW04	750112MW04	750112MW04	750112MK04	750112MW04	750112MW04	750112MW04	750112MW04



### Care advice

- Before cleaning any bulbs or lamps, make sure they are switched off and let them cool thoroughly to avoid any risk of burning yourself.
- For the lamp to retain its quality over time, it should be cleaned with a soft cloth and any spills should be wiped off immediately using a clean, absorbent cloth.
- If you have any queries about care or want to order parts (LED bulbs), please contact Hermès Customer Service.

### Packing information

The lamp is packaged in an orange box  
105x47x46 cm – 21 kg  
(41<sup>5/16</sup>x18<sup>1/2</sup>x8<sup>1/4</sup> in).

# Floor lamp Harnais

## Floor lamp

Direct and diffused light,  
dimmer switch.

Structure in nickel-plated steel.

Metallic branches covered in smooth  
bull calf leather, saddle-stitch finish.

Base in galvanised steel covered  
in leather.

Shade in opaline glass.

Covered cable and transformer  
protected by a leather sheath.

Designer: Michele de Lucchi

Made in Italy

- + Like the reins of a harness that connect a horse to its rider, those of the lamps in this collection connect the lamp shade to its base.
- + It is a marriage of saddle-stitched leather and opaline glass, fixed with three "clou de selle" studs.

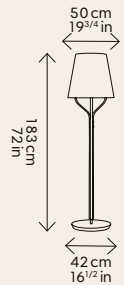

Light source: 25 + 3 x 8-W LED  
Colour temperature: 2,700 °K  
Voltage: 100 - 240 V



Gold smooth bull calf, 750111ME01

## Finishes

### Smooth bull calf

gold

rouge H

étaupe

graphite

# Floor lamp Harnais

## References

FINISH	AUSTRALIA	CHINA	EUROPE	JAPAN	KOREA	SINGAPOUR	TAIWAN	UK & HK	USA & CANADA
Smooth bull calf gold / Opaline glass	750111MA01	750111MC01	750111ME01	750111MJ01	750111MK01	750111ME01	750111MT01	750111MG01	750111MU01
Smooth bull calf rouge H / Opaline glass	750111MA02	750111MC02	750111ME02	750111MJ02	750111MK02	750111ME02	750111MT02	750111MG02	750111MU02
Smooth bull calf étoupe / Opaline glass	750111MA03	750111MC03	750111ME03	750111MJ03	750111MK03	750111ME03	750111MT03	750111MG03	750111MU03
Smooth bull calf graphite / Opaline glass	750111MA04	750111MC04	750111ME04	750111MJ04	750111MK04	750111ME04	750111MT04	750111MG04	750111MU04



### Care advice

- Before cleaning any bulbs or lamps, make sure they are switched off and let them cool thoroughly to avoid any risk of burning yourself.
- For the lamp to retain its quality over time, it should be cleaned with a soft cloth and any spills should be wiped off immediately using a clean, absorbent cloth.
- If you have any queries about care or want to order parts (LED bulbs), please contact Hermès Customer Service.

### Packing information

1 package with a total weight of 154 kg.  
Package size: 171x85x165 cm  
(67<sup>5/16</sup>x33<sup>7/16</sup>x64<sup>15/16</sup> in).

## CARPETS

Cordélie

## FURNITURE

Ancelle d'Hermès  
Atout d'Hermès  
Chaise Conservatoire  
Contour d'Hermès  
Équilibre d'Hermès  
Équipages d'Hermès  
Equis d'Hermès  
Hippodrome d'Hermès  
Karumi  
The Sellier Chair  
Les Nécessaires d'Hermès  
Les Trotteuses d'Hermès  
Lignage d'Hermès  
Métiers  
Oria d'Hermès  
Persiennes  
Pippa  
Jean-Michel Frank furniture  
designs by Hermès  
Sillage d'Hermès  
Sofa Sellier  
Tray-Tôt

## LIGHTING

Coulisse  
Halo  
Hécate  
Harnais  
**Lanterne d'Hermès**  
Pantographe  
Sarazine

# Lanterne d'Hermès

Yann Kersalé drew inspiration from the nautical world in creating the Lanterne d'Hermès. It is reminiscent of lighthouses and navigation lighting. He also dove deep into Hermès' past, exploring the era of horse-drawn carriages, which were also equipped with lanterns in both the front and back. The French visual artist has thus created for Hermès a lighting tool that exudes poetry and fantasy. This portable lantern is an invitation to travel, and is ideal for both indoor and outdoor use. It illuminates the traveller's way, shedding light on his path from four light sources.

Designer Yann Kersalé, French visual artist

# Lamp Lanterne d'Hermès

## Nomad lamp

Composed of four individual lanterns covered in water-resistant smooth bull calf leather, with double light, direct and diffused. Individual handle covered in leather, polished saddle-stitch finish. Recharge station covered in leather. Central axis in nickel-plated aluminium with a leather handle, saddle-stitch finish. Covered cable and transformer protected by a leather sheath. Rechargeable battery with a life of eight hours. Temporary exterior use.

Designer: Yann Kersalé  
Made in Italy

- + Materials were chosen to suit their specific purpose: aluminium for a light and rigid base, water-resistant leather for protection, and tempered glass for its enduring optical characteristics.



Gold smooth bull calf, 750211ME01

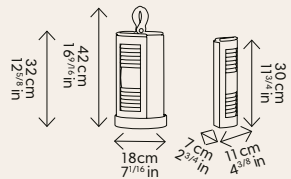

Light source (by lamp): 4-W LED  
Colour temperature: 3,000 °K  
Voltage: 100 - 240 V

## Finishes

### Smooth bull calf

gold      rouge H      étoupe      graphite

# Lamp Lanterne d'Hermès

## References

FINISH	AUSTRALIA	CHINA	EUROPE	JAPAN	KOREA	SINGAPOUR	TAIWAN	UK & HK	USA & CANADA
Smooth bull calf gold / Tempered glass	750211MA01	750211MC01	750211ME01	750211MJ01	750211MK01	750211ME01	750211MT01	750211MG01	750211MU01
Smooth bull calf rouge H / Tempered glass	750211MA02	750211MC02	750211ME02	750211MJ02	750211MK02	750211ME02	750211MT02	750211MG02	750211MU02
Smooth bull calf étoupe / Tempered glass	750211MA03	750211MC03	750211ME03	750211MJ03	750211MK03	750211ME03	750211MT03	750211MG03	750211MU03
Smooth bull calf graphite / Tempered glass	750211MA04	750211MC04	750211ME04	750211MJ04	750211MK04	750211ME04	750211MT04	750211MG04	750211MU04

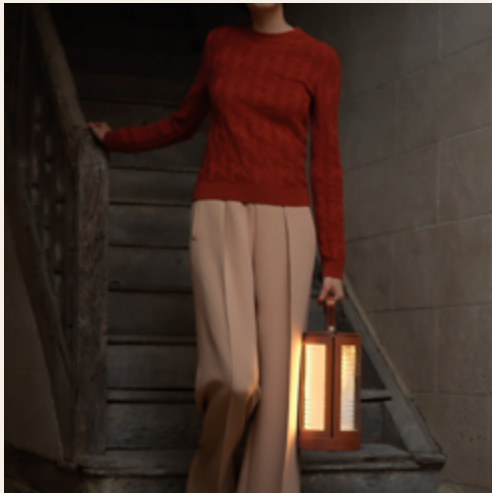

### Care advice

- Before cleaning any bulbs or lamps, make sure they are switched off and let them cool thoroughly to avoid any risk of burning yourself.
- For the lamp to retain its quality over time, it should be cleaned with a soft cloth and any spills should be wiped off immediately using a clean, absorbent cloth.
- If you have any queries about care or want to order parts (LED bulbs), please contact Hermès Customer Service.

### Packing information

The lamp is packaged in an orange box.



## CARPETS

Cordélie

## FURNITURE

Ancelle d'Hermès  
Atout d'Hermès  
Chaise Conservatoire  
Contour d'Hermès  
Équilibre d'Hermès  
Équipages d'Hermès  
Equis d'Hermès  
Hippodrome d'Hermès  
Karumi  
The Sellier Chair  
Les Nécessaires d'Hermès  
Les Trotteuses d'Hermès  
Lignage d'Hermès  
Métiers  
Oria d'Hermès  
Persiennes  
Pippa  
Jean-Michel Frank furniture  
designs by Hermès  
Sillage d'Hermès  
Sofa Sellier  
Tray-Tôt

## LIGHTING

Coulisse  
Halo  
Hécate  
Harnais  
Lanterne d'Hermès  
**Pantographe**  
Sarazine

# Pantographe

The tool for drawing known as the pantograph has given its name to this collection of lights. Like the architect's instrument that serves to reduce or enlarge a picture, this collection owes its originality to the articulated stems and arms that make up the bodies of its three lights. The lights are agile and follow the hand to illuminate every gesture.

Covered in leather and metal, the lighting elements are reminiscent of whips and an equestrian world. The finishes are exquisite, carefully-considered, and highly sophisticated. The base becomes a trinket tray, the wiring is hidden and electric cables are covered in leather. Meticulous attention has been given to detail.

Designer Michele de Lucchi, Italian architect and designer

# Desk lamp Pantographe

## Desk lamp

Direct light, dimmer switch.  
Articulated structure in nickel-plated aluminium covered in smooth bull calf leather.  
Metal "change tray" base covered in leather.  
Covered cable and transformer protected by a leather sheath.

Designer: Michele de Lucchi  
Made in Italy

- + The drawing instrument known as a pantograph has given its name to this collection of lamps.
- + These are agile lights that follow the hand to illuminate every gesture.

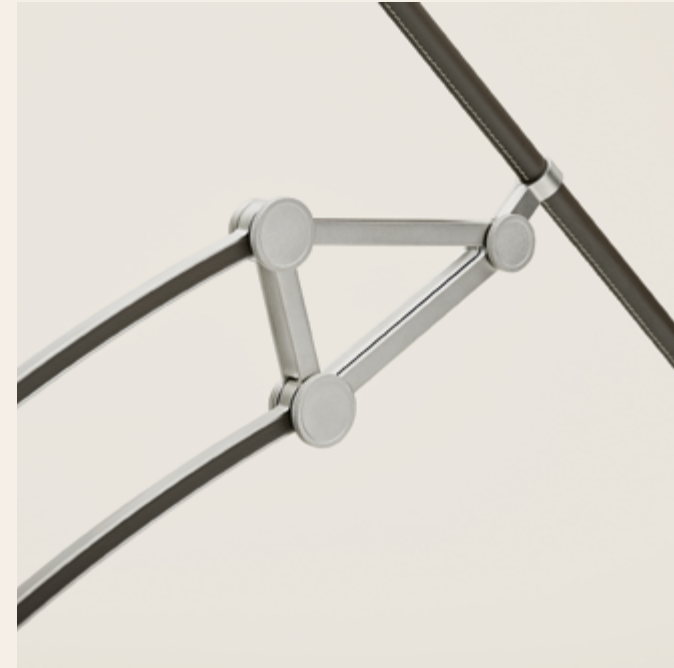

Graphite smooth bull calf, 750013MW04

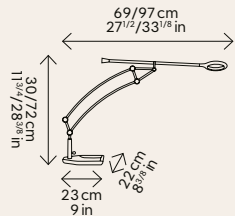

Light source: 7-W LED  
Colour temperature: 2,700 °K  
Voltage: 100 - 240 V

## Finishes

### Smooth bull calf

gold      rouge H      étoupe      graphite

# Desk lamp Pantographe

## References

FINISH	AUSTRALIA	CHINA	EUROPE	JAPAN	KOREA	SINGAPOUR	TAIWAN	UK & HK	USA & CANADA
Smooth bull calf gold	750013MW01	750013MW01	750013MW01	750013MW01	750013MK01	750013MW01	750013MW01	750013MW01	750013MW01
Smooth bull calf rouge H	750013MW02	750013MW02	750013MW02	750013MW02	750013MK02	750013MW02	750013MW02	750013MW02	750013MW02
Smooth bull calf étoupe	750013MW03	750013MW03	750013MW03	750013MW03	750013MK03	750013MW03	750013MW03	750013MW03	750013MW03
Smooth bull calf graphite	750013MW04	750013MW04	750013MW04	750013MW04	750013MK04	750013MW04	750013MW04	750013MW04	750013MW04



### Care advice

- Before cleaning any bulbs or lamps, make sure they are switched off and let them cool thoroughly to avoid any risk of burning yourself.
- For the lamp to retain its quality over time, it should be cleaned with a soft cloth and any spills should be wiped off immediately using a clean, absorbent cloth.
- If you have any queries about care or want to order parts (LED bulbs), please contact Hermès Customer Service.

### Packing information

The lamp is packaged in an orange box.

# Reading floor lamp Pantographe

## Reading floor lamp

Direct light, dimmer switch.  
Articulated structure in nickel-plated aluminium covered in smooth bull calf leather.  
Base in galvanised steel covered in leather.  
Covered cable and transformer protected by a leather sheath.

Designer: Michele de Lucchi  
Made in Italy

- + The drawing instrument known as a pantograph has given its name to this collection of lamps.
- + These are agile lights that follow the hand to illuminate every gesture.

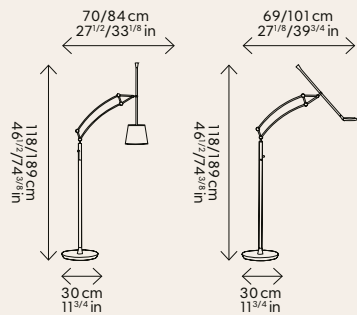

Silk twill-covered shade version light source: 12-W LED  
LED-ring version light source: 7-W LED  
Colour temperature: 2,700 °K  
Voltage: 100 - 240 V



Silk twill-covered shade version, gold smooth bull calf, 750012MW01



LED-ring version, rouge H smooth bull calf, 750014MW02

## Finishes

### Smooth bull calf

gold      rouge H      étoupe      graphite

# Reading floor lamp Pantographe

## References

	FINISH	AUSTRALIA	CHINA	EUROPE	JAPAN	KOREA	SINGAPOUR	TAIWAN	UK & HK	USA & CANADA
Reading floor lamp with shade	Smooth bull calf gold / twill Vice-Versa	750012MW01	750012MW01	750012MW01	750012MW01	750012MK01	750012MW01	750012MW01	750012MW01	750012MW01
	Smooth bull calf rouge H / twill Vice-Versa	750012MW02	750012MW02	750012MW02	750012MW02	750012MK02	750012MW02	750012MW02	750012MW02	750012MW02
	Smooth bull calf étoupe / twill Vice-Versa	750012MW03	750012MW03	750012MW03	750012MW03	750012MK03	750012MW03	750012MW03	750012MW03	750012MW03
	Smooth bull calf graphite / twill Vice-Versa	750012MW04	750012MW04	750012MW04	750012MW04	750012MK04	750012MW04	750012MW04	750012MW04	750012MW04

	FINISH	AUSTRALIA	CHINA	EUROPE	JAPAN	KOREA	SINGAPOUR	TAIWAN	UK & HK	USA & CANADA
Reading floor lamp with LED-ring	Smooth bull calf gold	750014MW01	750014MW01	750014MW01	750014MW01	750014MK01	750014MW01	750014MW01	750014MW01	750014MW01
	Smooth bull calf rouge H	750014MW02	750014MW02	750014MW02	750014MW02	750014MK02	750014MW02	750014MW02	750014MW02	750014MW02
	Smooth bull calf étoupe	750014MW03	750014MW03	750014MW03	750014MW03	750014MK03	750014MW03	750014MW03	750014MW03	750014MW03
	Smooth bull calf graphite	750014MW04	750014MW04	750014MW04	750014MW04	750014MK04	750014MW04	750014MW04	750014MW04	750014MW04

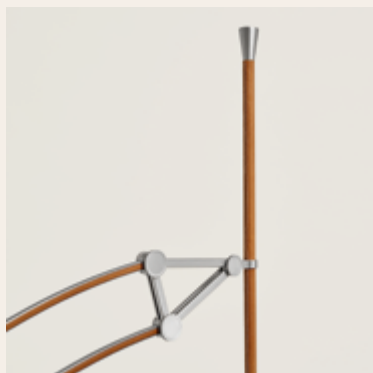

### Care advice

- Before cleaning any bulbs or lamps, make sure they are switched off and let them cool thoroughly to avoid any risk of burning yourself.
- For the lamp to retain its quality over time, it should be cleaned with a soft cloth and any spills should be wiped off immediately using a clean, absorbent cloth.
- If you have any queries about care or want to order parts (LED bulbs), please contact Hermès Customer Service.

### Packing information

1 package with a total weight of 75 kg.  
 Package size: 203x66x58.5 cm  
 (79<sup>5/16</sup>x26x23 in).

# Arch floor lamp Pantographe

## Arch floor lamp

Direct light, double dimmer switch.  
Articulated structure in nickel-plated aluminium covered in smooth bull calf leather.  
Base in galvanised steel covered in leather.  
Silk twill-covered shade.  
Covered cable and transformer protected by a leather sheath.

Designer: Michele de Lucchi  
Made in Italy

- + The drawing instrument known as a pantograph has given its name to this collection of lamps.
- + These are agile lights that follow the hand to illuminate every gesture.

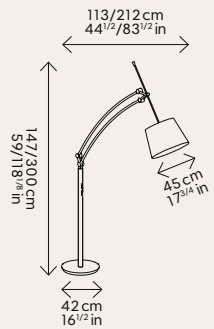

Light source : 25W + 10W-LED  
Colour temperature : 2,700 °K  
Voltage : 100 - 240 V



Gold smooth bull calf, 750012MW01

## Finishes

### Smooth bull calf

gold      rouge H      étoupe      graphite

# Arch floor lamp Pantographe

## References

FINISH	AUSTRALIA	CHINA	EUROPE	JAPAN	KOREA	SINGAPOUR	TAIWAN	UK & HK	USA & CANADA
Smooth bull calf gold / twill Vice-Versa	750011MA01	750011MC01	750011ME01	750011MJ01	750011MK01	750011ME01	750011MT01	750011MG01	750011MU01
Smooth bull calf rouge H / twill Vice-Versa	750011MA02	750011MC02	750011ME02	750011MJ02	750011MK02	750011ME02	750011MT02	750011MG02	750011MU02
Smooth bull calf étoupe / twill Vice-Versa	750011MA03	750011MC03	750011ME03	750011MJ03	750011MK03	750011ME03	750011MT03	750011MG03	750011MU03
Smooth bull calf graphite / twill Vice-Versa	750011MA04	750011MC04	750011ME04	750011MJ04	750011MK04	750011ME04	750011MT04	750011MG04	750011MU04



### Care advice

- Before cleaning any bulbs or lamps, make sure they are switched off and let them cool thoroughly to avoid any risk of burning yourself.
- For the lamp to retain its quality over time, it should be cleaned with a soft cloth and any spills should be wiped off immediately using a clean, absorbent cloth.
- If you have any queries about care or want to order parts (LED bulbs), please contact Hermès Customer Service.

### Packing information

1 package with a total weight of 147 kg.  
Package size: 191x109x80 cm  
(75<sup>3/16</sup>x42<sup>15/16</sup>x31<sup>1/2</sup> in).

## CARPETS

## FURNITURE

Ancelle d'Hermès  
Atout d'Hermès  
Chaise Conservatoire  
Contour d'Hermès  
Équilibre d'Hermès  
Équipages d'Hermès  
Equis d'Hermès  
Hippodrome d'Hermès  
Karumi  
The Sellier Chair  
Les Nécessaires d'Hermès  
Les Trotteuses d'Hermès  
Lignage d'Hermès  
Métiers  
Oria d'Hermès  
Persiennes  
Pippa  
Jean-Michel Frank furniture  
designs by Hermès  
Sillage d'Hermès  
Sofa Sellier  
Tray-Tôt

## LIGHTING

Coulisse  
Halo  
Hécate  
Harnais  
Lanterne d'Hermès  
Pantographe  
**Sarazine**

# Sarazine

A lampshade made of writing paper and a structure in full H bull calf leather, beautifully saddle-stitched. In 1996, Jean-Michel Sarazin, an artisan in the trunks workshop, took the emblematic materials and know-how of Hermès and designed a table lamp. This is a study in style, a timeless creation that has now been reborn, and is available in a small and large size.

Designer Hermès Studio, after Jean-Michel Sarazin



# Table lamp Sarazine

## Table lamp

Sheathing of H bull calf on a metal base, paper lampshade, metal pieces in electroplated brass. One bulb on the small model, two bulbs on the large one.

Designer: Hermès Studio,  
after Jean-Michel Sarazin  
Made in France and in Italy

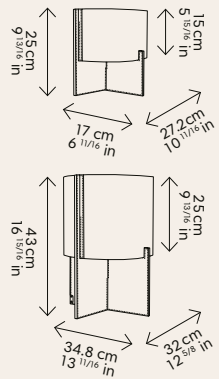

Lighting source : 1 or 2 LED bulbs E14, E17 or E12 depending on the area.  
Voltage: 100 - 240 V



Small model, tabac H bull calf, 750098M 02



Large model, rouge H bull calf, 750099M 01

## Finishes

### H bull calf leather

rouge H

tabac

### Natural cowhide

naturel

### H bull calf leather

rouge H

tabac

# Table lamp Sarazine

## References

LAMP PM	FINISH	AUSTRALIA	CHINA	EUROPE	JAPAN	KOREA	SINGAPOUR	TAIWAN	UK & HK	USA & CANADA
	H bull calf leather rouge H / Paper shade	750098MA01	750098MC01	750098ME01	750098MJ01	750098MK01	750098MS01	750098MT01	750098MG01	750098MU01
	H bull calf leather H tabac / Paper shade	750098MA02	750098MC02	750098ME02	750098MJ02	750098MK02	750098MS02	750098MT02	750098MG02	750098MU02
	Natural cowhide / Paper shade	750100MA01	750100MC01	750100ME01	750100MJ01	750100MK01	750100MS01	750100MT01	750100MG01	750100MU01

LAMP GM	FINISH	AUSTRALIA	CHINA	EUROPE	JAPAN	KOREA	SINGAPOUR	TAIWAN	UK & HK	USA & CANADA
	H bull calf leather rouge H / Paper shade	750099MA01	750099MC01	750099ME01	750099MJ01	750099MK01	750099MS01	750099MT01	750099MG01	750099MU01
	H bull calf leather H tabac / Paper shade	750099MA02	750099MC02	750099ME02	750099MJ02	750099MK02	750099MS02	750099MT02	750099MG02	750099MU02



### Care advice

- Before cleaning any bulbs or lamps, make sure they are switched off and let them cool thoroughly to avoid any risk of burning yourself.
- For the lamp to retain its quality over time, it should be cleaned with a soft cloth and any spills should be wiped off immediately using a clean, absorbent cloth.
- If you have any queries about care or want to order parts, please contact Hermès Customer Service.

### Packing information

- Small model:  
1 package with a total weight of 6 kg  
Orange box size: 52 x 33 x 46 cm  
(20<sup>15/32</sup> x 12<sup>63/64</sup> x 18<sup>7/64</sup> in).
- Large model:  
1 package with a total weight of 9.3 kg  
Orange box size: 81 x 47 x 51 cm  
(31<sup>57/64</sup> x 18<sup>1/2</sup> x 20<sup>5/64</sup> in).

# Materials

Wood

Leather

Exceptional finish

Fabrics

Stones

Metals

# Wood

## MATERIALS

### Wood

Leather

Exceptional finish

Fabrics

Stones

Metals

Natural oak

Canaletto walnut

Ebonised walnut wood

Natural maple

Ebonised maple wood

Pearwood

Natural ceruse-finished oak

Brown ceruse-finished oak

Bamboo

Wicker

Rattan

# Natural oak

- + Natural - Robust - Durable
- + Appearance: naturally light blond
- + Strengths: robust
- + Evolution over time: slight yellowing and/or darkening
- + Care: to preserve the beauty of wood, we advise cleaning it with a soft, dry cloth. In the event of a stain, wipe with a cloth moistened with water and dry immediately with a soft cloth. If the stain persists, do not hesitate to contact your Hermès store
- + Origin: Europe



**Natural oak**

# Canaletto walnut

- + Solid - Stable - Timeless
- + Appearance: flamed, expressive, silky, a pattern of dark flamed or striped veins contrasting with lighter tones
- + Strengths: solid, stable, timeless, its warm and soft colour
- + Evolution over time: may lighten with exposure to light
- + Care: to preserve the beauty of wood, we advise cleaning it with a soft, dry cloth. In the event of a stain, wipe with a cloth moistened with water and dry immediately with a soft cloth. If the stain persists, do not hesitate to contact your Hermès store
- + Origin: North America



**Canaletto walnut**



# Ebonised walnut wood

- + Solid - Stable - Timeless
- + Appearance: elegant, silky
- + Strengths: solid, stable, excellent durability
- + Evolution over time: stable
- + Care: to preserve the beauty of wood, we advise cleaning it with a soft, dry cloth. In the event of a stain, wipe with a cloth moistened with water and dry immediately with a soft cloth. If the stain persists, do not hesitate to contact your Hermès store
- + Origin: North America



# Natural maple

- + Slightly wavy grain - Fine grain - Consistent
- + Appearance: silky, clear
- + Strengths: contemporary, excellent durability, perfect for everyday use
- + Evolution over time: turns golden if exposed to light
- + Care: to preserve the beauty of wood, we advise cleaning it with a soft, dry cloth. In the event of a stain, wipe with a cloth moistened with water and dry immediately with a soft cloth. If the stain persists, do not hesitate to contact your Hermès store
- + Origin: Europe



# Ebonised maple wood

- + Slightly wavy grain - Fine grain - Consistent
- + Appearance: silky
- + Strengths: contemporary, excellent durability, perfect for everyday use
- + Care: to preserve the beauty of wood, we advise cleaning it with a soft, dry cloth. In the event of a stain, wipe with a cloth moistened with water and dry immediately with a soft cloth. If the stain persists, do not hesitate to contact your Hermès store
- + Origin: Europe





# Pearwood

- + Fine Grain - Consistent - Solid
- + Appearance: light wood with a pinkish tone, silky
- + Strengths: valuable
- + Evolution over time: the colour darkens
- + Care: to preserve the beauty of wood, we advise cleaning it with a soft, dry cloth. In the event of a stain, wipe with a cloth moistened with water and dry immediately with a soft cloth. If the stain persists, do not hesitate to contact your Hermès store
- + Origin: Europe



# Natural ceruse-finished oak

- + Natural - Robust - Durable
- + Appearance: white veins on a natural background
- + Strengths: robust
- + Evolution over time: stable
- + Care: to preserve the beauty of wood, we advise cleaning it with a soft, dry cloth. In the event of a stain, wipe with a cloth moistened with water and dry immediately with a soft cloth. If the stain persists, do not hesitate to contact your Hermès store
- + Origin: Europe





# Brown ceruse-finished oak

- + Precious wood - Robust - Durable
- + Appearance: light beige to light brown wood base, slightly mottled
- + Strengths: robust
- + Evolution over time: stable
- + Care: to preserve the beauty of wood, we advise cleaning it with a soft, dry cloth. In the event of a stain, wipe with a cloth moistened with water and dry immediately with a soft cloth. If the stain persists, do not hesitate to contact your Hermès store
- + Origin: Europe



# Bamboo

- + Flexible - Robust - Lightweight
- + Appearance: light-coloured wood with visible and accepted tone-on-tone knots, visible glued laminate technique, silky
- + Strengths: lightness, refinement, precious craftsmanship, robustness
- + Evolution over time: slightly yellowing in the light
- + Care: to preserve the beauty of wood, we advise cleaning it with a soft, dry cloth. In the event of a stain, wipe with a cloth moistened with water and dry immediately with a soft cloth. If the stain persists, do not hesitate to contact your Hermès store
- + Origin: Japan



# Wicker

- + Natural - Flexible - Solid
- + Appearance: several intertwined fibres, light yellow colour
- + Strengths: strong, 100% natural fibre, supple and light
- + Evolution over time: prolonged humidity can deform and discolour wicker furniture
- + Care: we recommend using a feather duster. In the event of a stain, avoid dampening the rattan. It is best to use a paper towel, or if necessary a slightly damp sponge, and then dry immediately by dabbing with a soft cotton cloth
- + Origin: France





# Rattan

- + Natural – Resistant
- + Appearance: several intertwined fibres, light brown colour
- + Strengths: strong, 100% natural fibre and light
- + Evolution over time : from pale brown to yellow over time
- + Care: we recommend using a feather duster. In the event of a stain, avoid dampening the rattan. It is best to use a paper towel, or if necessary, a slightly damp sponge, and then dry immediately by dabbing with a soft cotton cloth
- + Origin: France

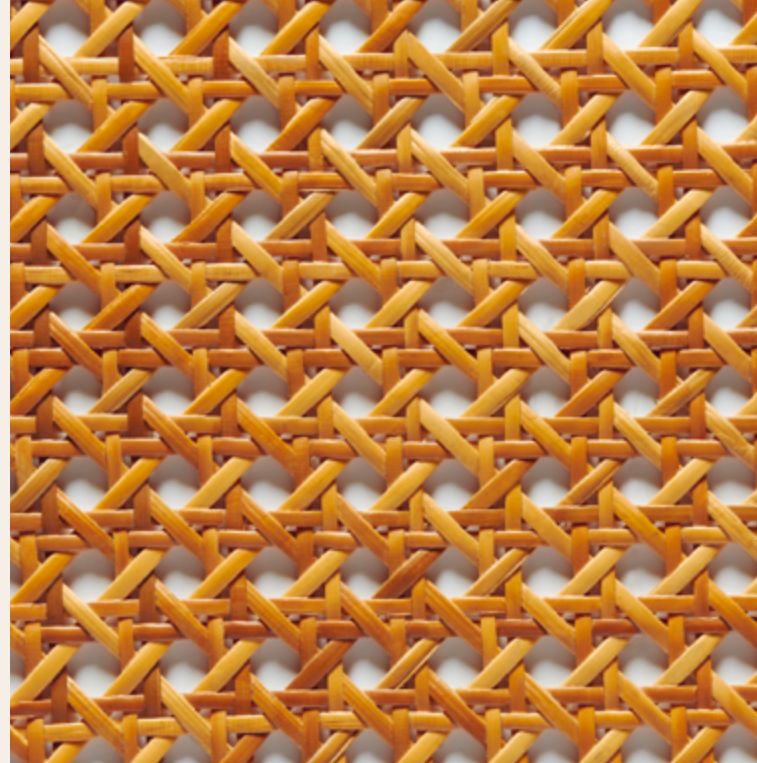

# Leather

## MATERIALS

Wood

**Leather**

Exceptional finish

Fabrics

Stones

Metals

Bridle leather

Sheepskin

Clémence bull calf leather

Everlisse bull calf leather

H bull calf leather

Glazed bull calf leather

Smooth bull calf leather

Natural cowhide

Smooth calfskin

# Bridle leather

- + Robust - Smooth - Thick
- + Appearance: natural, smooth, thick
- + Finish: anilin
- + Touch: supple, soft, slightly waxy
- + Hand feel: firm
- + Strengths: elegance and authenticity, robustness
- + Evolution over time: acquires patina and lightens in the most stressed areas, softening over time, darkening in the light
- + Care: leather simply needs to be cleaned regularly with a soft, dry, lint-free cloth. Blot any stains immediately with a paper towel. If the stain persists, do not hesitate to contact your Hermès store. We do not recommend applying "Raviv' Cuir" leather cleaning lotion to our leathers
- + Origin: Europe

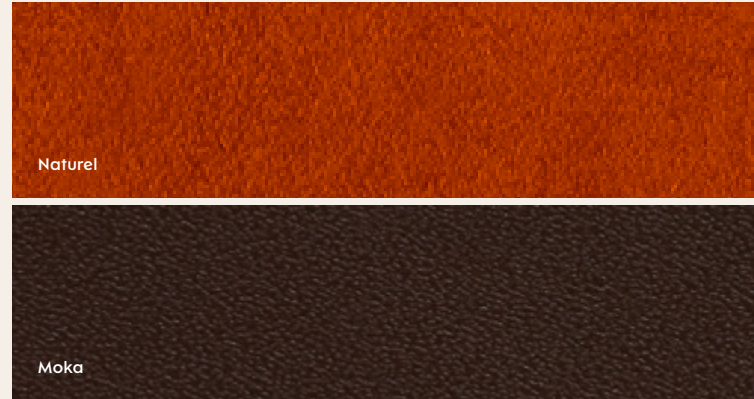

# Sheepskin

- + Curly – Soft – Warm
- + Appearance: curly, warm
- + Finish: woolly sheepskin with curly finish
- + Touch: dense and rounded
- + Strengths: soft, comfortable, warm character
- + Evolution over time: stable
- + Care: vacuum with a soft brush once a month to remove dust. Blot any stains with white paper towels as quickly as possible
- + Origin: Australian sheep



# Clémence bull calf leather

- + Generous - Soft - Grained
- + Appearance: semi-matt, generous and irregular grain
- + Finish: pigmented
- + Touch: soft, smooth
- + Hand feel: soft
- + Strengths: wide choice of colours, robust
- + Evolution over time: flexibility increases
- + Care: leather simply needs to be cleaned regularly with a soft, dry, lint-free cloth. Blot any stains immediately with a paper towel. If the stain persists, do not hesitate to contact your Hermès store. We do not recommend applying "Raviv' Cuir" leather cleaning lotion to our leathers
- + Origin: Europe

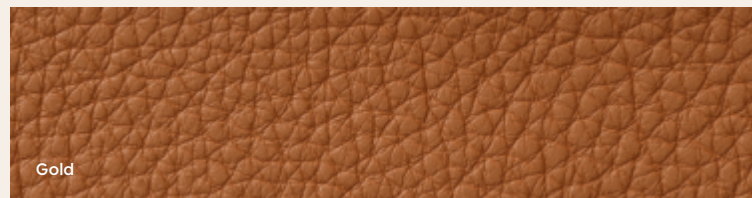



# Everlisse bull calf leather

- + Smooth - Uniform - Shiny
- + Appearance: smooth and shiny
- + Finish: pigmented
- + Touch: soft
- + Hand feel: firm
- + Strengths: wide range of colours, uniform colour, robustness
- + Evolution over time: patina and shine in the most stressed areas
- + Care: leather simply needs to be cleaned regularly with a soft, dry, lint-free cloth. Blot any stains immediately with a paper towel. If the stain persists, do not hesitate to contact your Hermès store. We do not recommend applying "Raviv' Cuir" leather cleaning lotion to our leathers
- + Origin: Europe

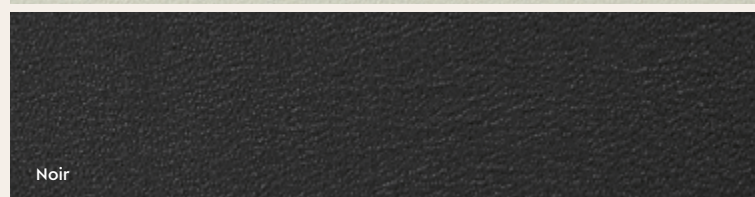
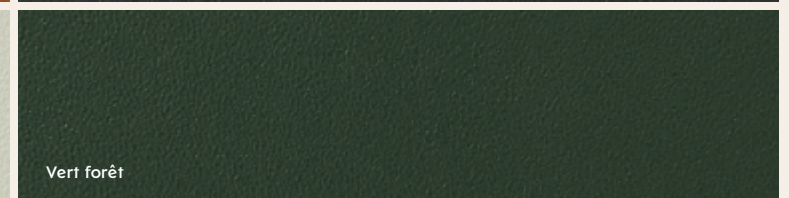
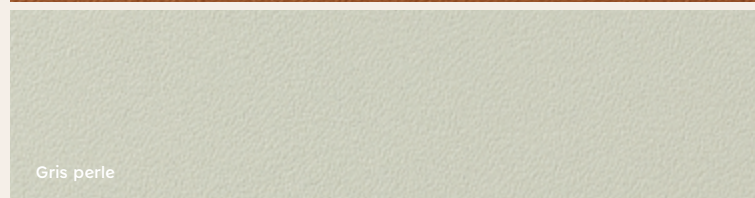
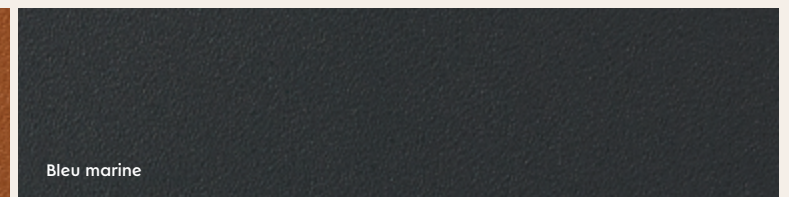
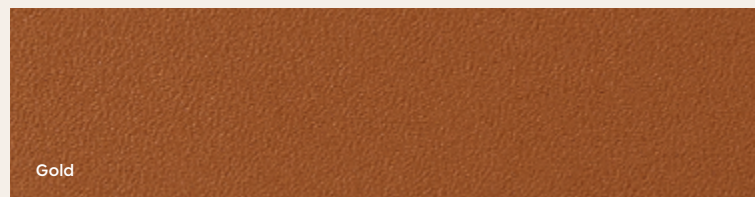
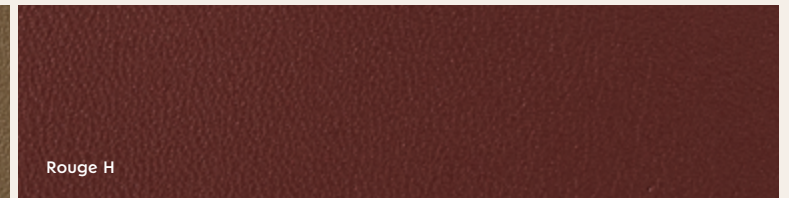
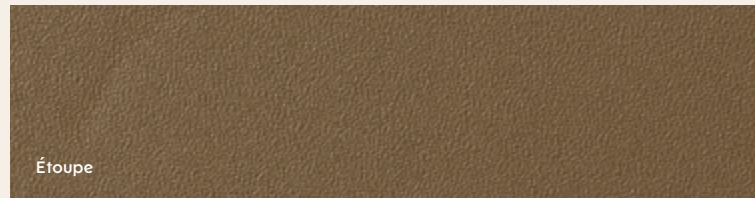
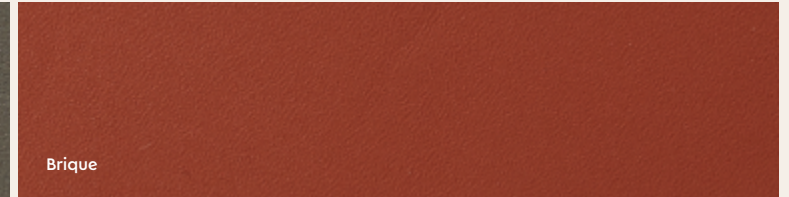

# Glazed bull calf

- + Delicate - Smooth - Thick
- + Aspect: smooth and shiny
- + Finish: semi-aniline
- + Touch: silky
- + Hand feel: semi-supple
- + Strengths: natural, three color choices
- + Evolution over time: patina and shine in the most stressed areas
- + Care: leather simply needs to be cleaned regularly with a soft, dry, lint-free cloth.  
Blot any stains immediately with a paper towel. If the stain persists, do not hesitate to contact your Hermès store. We do not recommend applying "Raviv' Cuir" leather cleaning lotion to our leathers
- + Origin: Europe

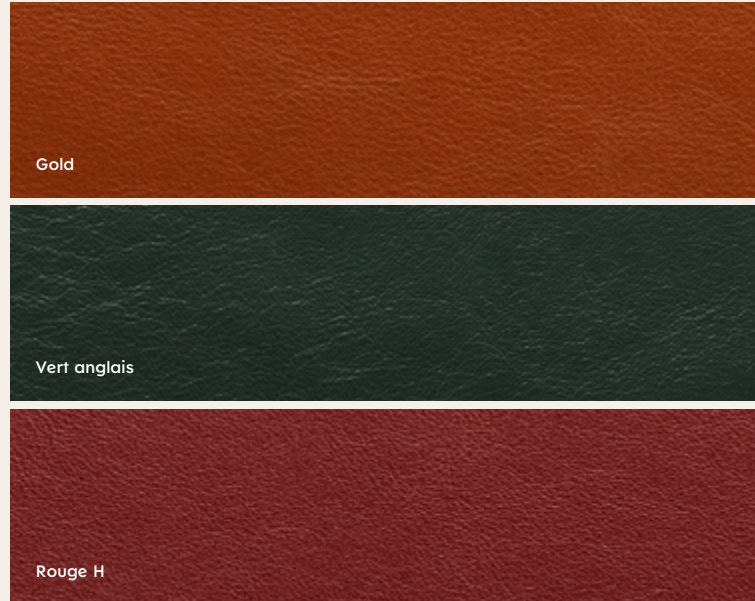



# H bull calf leather

- + Natural - Transparent - Unique
- + Appearance: irregular grain with little relief, transparent, consistent colour
- + Finish: anilin
- + Touch: silky, soft, waxy
- + Hand feel: soft, supple
- + Strengths: refinement, authenticity
- + Evolution over time: acquires patina and gloss, darkens
- + Care: leather simply needs to be cleaned regularly with a soft, dry, lint-free cloth. Blot any stains immediately with a paper towel. If the stain persists, do not hesitate to contact your Hermès store. We do not recommend applying "Raviv' Cuir" leather cleaning lotion to our leathers
- + Origin: Europe

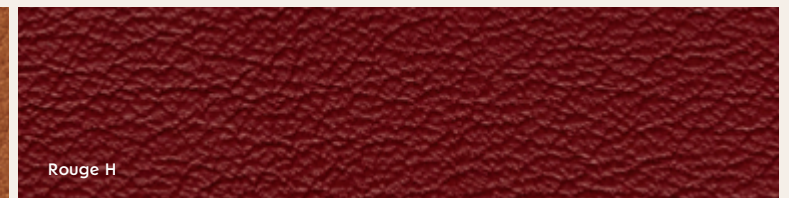
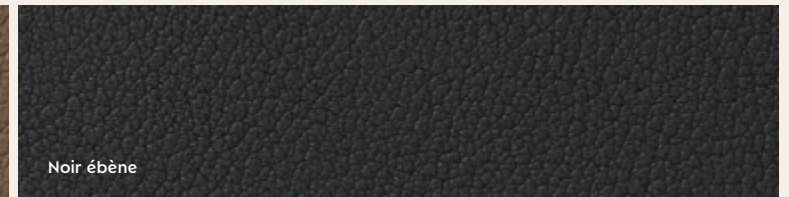
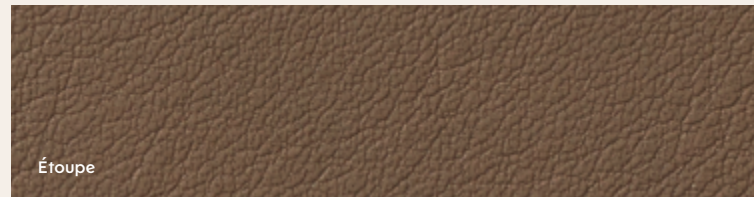
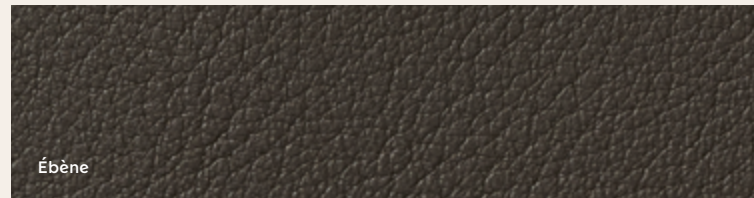
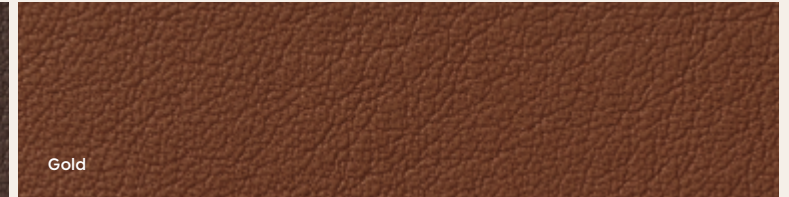



**H bull calf leather**

# Smooth bull calf leather

- + Light shine - Smooth - Robust
- + Appearance: fine grain but irregular in some places (depending on the part of the skin used: more obvious on the flanks and less on the backbone)
- + Finish: pigmented
- + Touch: soft, smooth
- + Hand feel: rounded, supple, soft
- + Strengths: robust, wide range of colours
- + Evolution over time: becomes glossy
- + Care: leather simply needs to be cleaned regularly with a soft, dry, lint-free cloth. Blot any stains immediately with a paper towel. If the stain persists, do not hesitate to contact your Hermès store. We do not recommend applying "Raviv' Cuir" leather cleaning lotion to our leathers
- + Origin: Europe

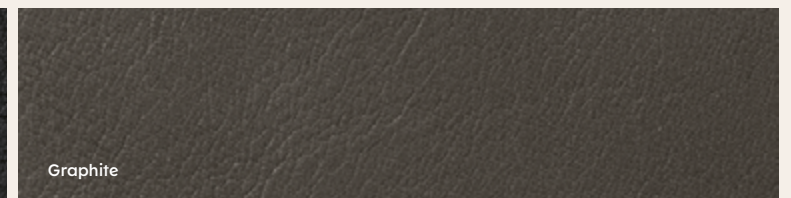
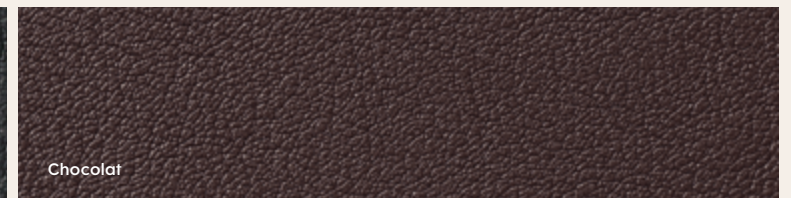
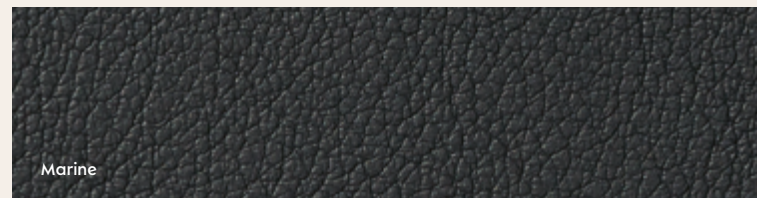
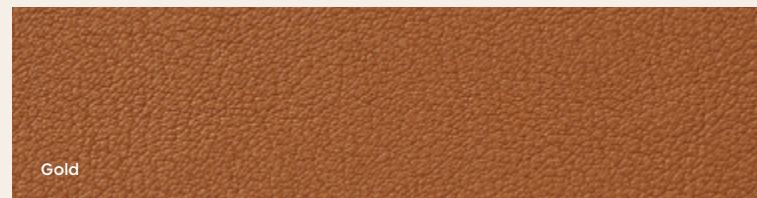
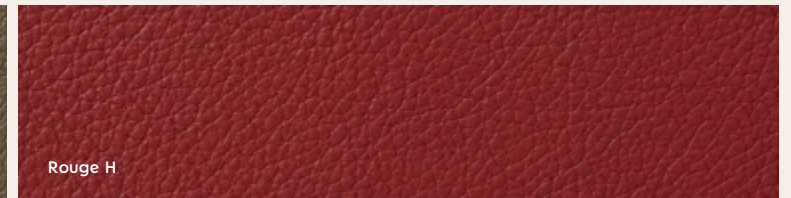

**Smooth bull calf leather**

# Natural cowhide

- + Thick - Robust - Fine grain
- + Appearance: smooth and compact, highly transparent, matte at first, natural dappled appearance
- + Finish: anilin
- + Touch: smooth, soft and silky
- + Hand feel: firm and full
- + Strengths: tradition, elegance, transparency, requires high-quality skins (natural skin)
- + Evolution over time: patina, colour change, particularly sensitive to light due to its transparent finish, but retains its strength and firmness
- + Care: leather simply needs to be cleaned regularly with a soft, dry, lint-free cloth. Blot any stains immediately with a paper towel. If the stain persists, do not hesitate to contact your Hermès store. We do not recommend applying "Raviv' Cuir" leather cleaning lotion to our leathers
- + Origin: Europe





# Smooth calfskin

- + Flexible - Matt - Uniform
- + Appearance: matt, imperceptible fuller's grain
- + Finish: semi-anilin
- + Touch: dry
- + Hand feel: supple
- + Strengths: consistent colour, robust, wide range of colours
- + Evolution over time: maintains its appearance, becomes satin-like in the most stressed areas
- + Care: leather simply needs to be cleaned regularly with a soft, dry, lint-free cloth. Blot any stains immediately with a paper towel. If the stain persists, do not hesitate to contact your Hermès store. We do not recommend applying "Raviv' Cuir" leather cleaning lotion to our leathers
- + Origin: France

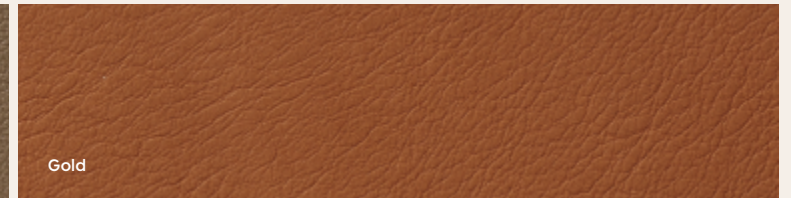
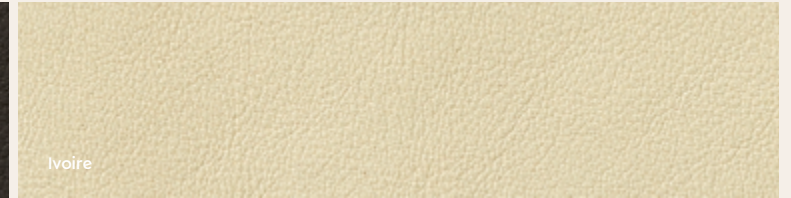

# Exceptional finish

## MATERIALS

Wood

Leather

Exceptional finish

Fabrics

Stones

Metals

Straw marquetry

# Straw marquetry

- + Radiant - Bright - Unique
- + Appearance: smooth, bright and deep gold shades
- + Strengths: adiant, valuable and unique
- + Evolution over time: slight lightening possible with exposure to light
- + Care: to preserve the beauty of the straw marquetry, gently wipe with a soft cloth in the direction of the straw fibres. Avoid exposure to heat, moisture and bright light
- + Origin: France



# Fabrics

## MATERIALS

Wood  
Leather  
Exceptional finish  
**Fabrics**  
Stones  
Metals

Cadre

Echelle

Entrelacs

Cheval Pixel

Cravache

Toile flammée

Toile H



# Cadre

- + 100% wool - Soft - Robust
- + Appearance: soft
- + Strengths: warm, pleasant and good elasticity
- + Care: for the care of fabric items, with or without removable covers, we recommend contacting your Hermès store and/or a professional cleaner
- + Origin: Britain



# Cheval Pixel

- + 100% cotton - Soft - Robust
- + Design by Philippe Mouquet
- + Appearance: thick
- + Strengths: robust, supple, warm
- + Evolution over time: durable
- + Care: for the care of fabric items, with or without removable covers, we recommend contacting your Hermès store and/or a professional cleaner
- + Origin: Italy

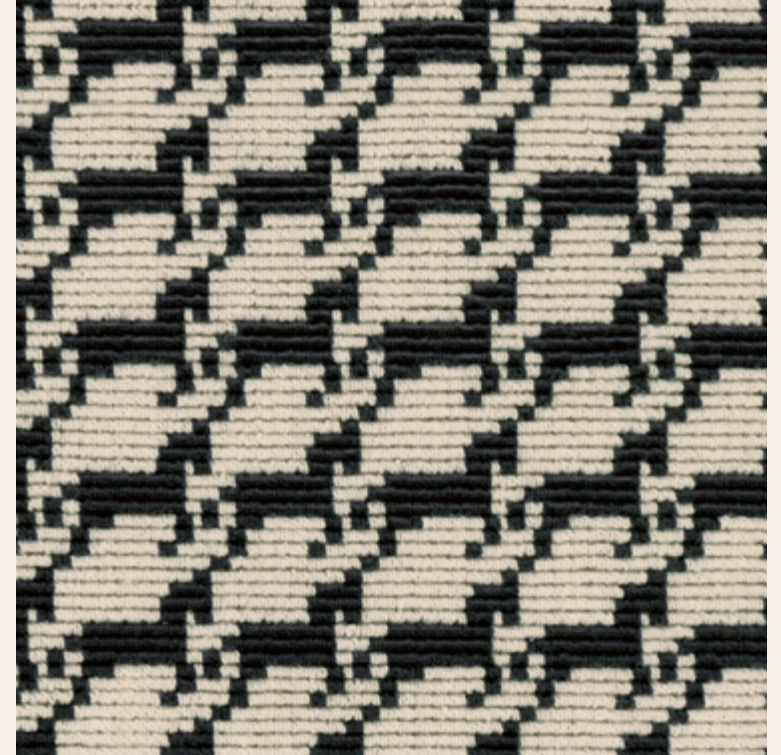



# Cravache

- + 56% abaca and 44% cotton - Natural - Robust
- + Design by Henri d'Origny
- + Appearance: glossy
- + Strengths: patterned fabric, robust, solid
- + Evolution over time: durable
- + Care: for the care of fabric items, with or without removable covers, we recommend contacting your Hermès store and/or a professional cleaner
- + Origin: Italy
- + For USA, UK, HKG and China, Cravache fabric is made of 100% polyester FR.

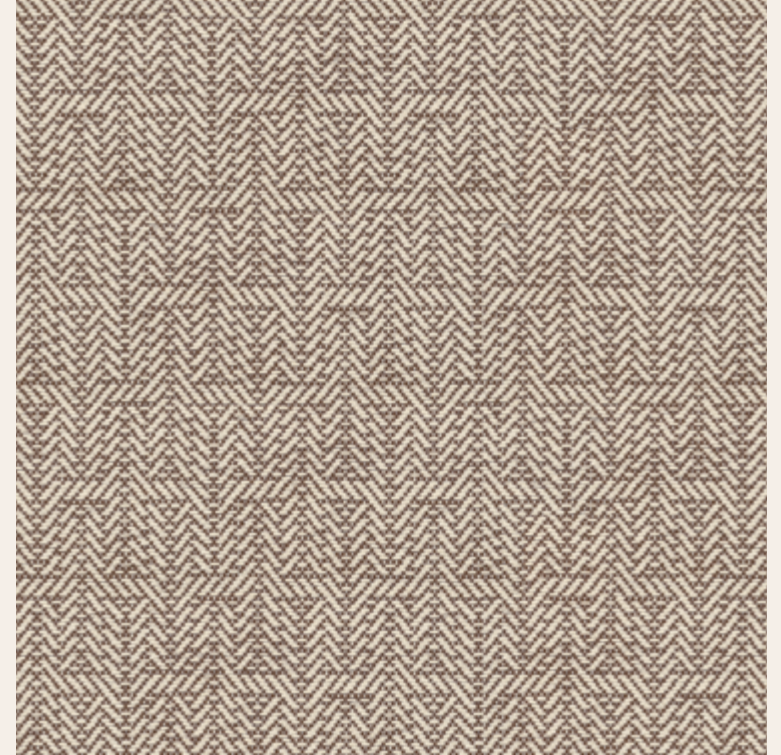
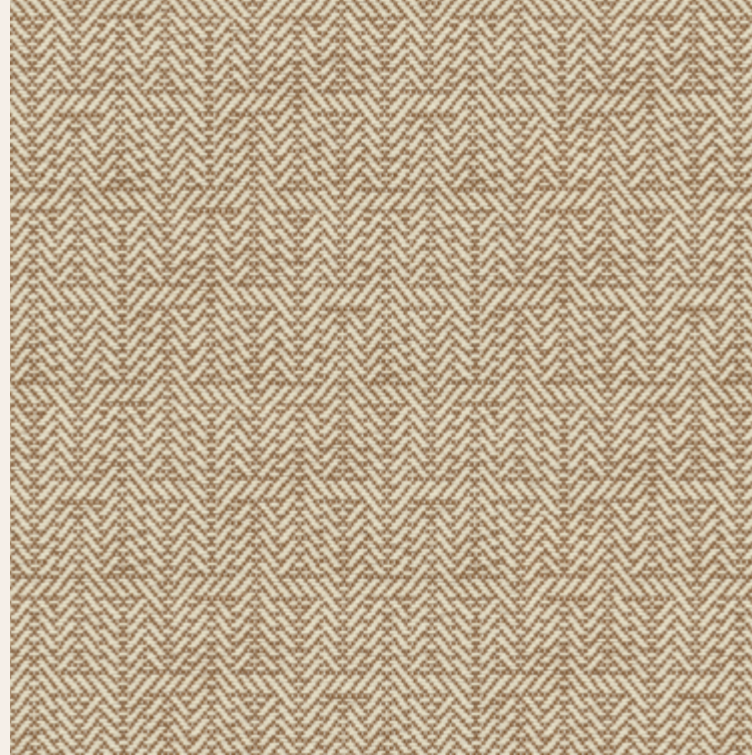

# Echelle

- + 100% wool - Soft - Robust
- + Appearance: soft
- + Strengths: warm, pleasant and good elasticity
- + Care: for the care of fabric items, with or without removable covers, we recommend contacting your Hermès store and/or a professional cleaner
- + Origin: Britain





# Entrelacs

- + 100% wool - Soft - Robust
- + Appearance: soft
- + Strengths: warm, pleasant and good elasticity
- + Care: for the care of fabric items, with or without removable covers, we recommend contacting your Hermès store and/or a professional cleaner
- + Origin: Britain



# Toile flammée

- + 70% wool and 30% cotton - Soft - Robust
- + Appearance: slightly irregular with tonal variations
- + Strengths: soft, supple
- + Evolution over time: robust, warm
- + Care: professional cleaning is recommended. For daily care, dust the fabric with a feather duster. In the event of accidental contact with liquid, we recommend wiping immediately and gently with an absorbent cloth
- + Origin: Italy

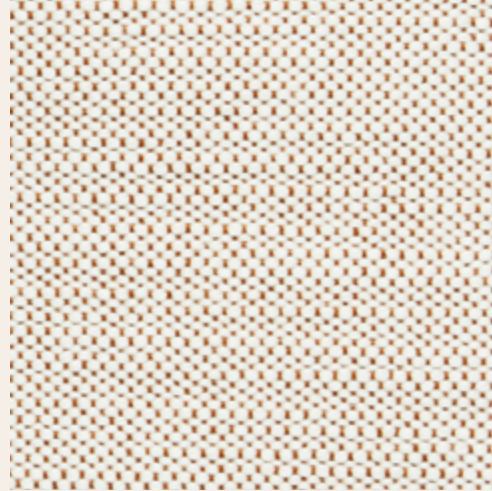

Cannelle



Gris ponce

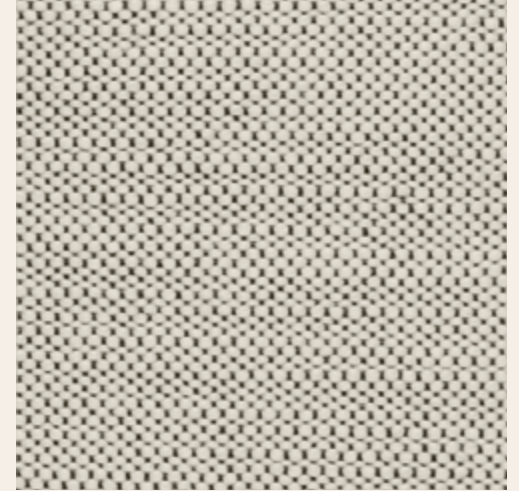

Ébène



Écru



# Toile H

- + 100% cotton - Warm - Robust
- + Appearance: thick
- + Strengths: robust, supple, warm
- + Evolution over time: durable
- + Care: for the care of fabric items, with or without removable covers, we recommend contacting your Hermès store and/or a professional cleaner
- + Origin: Italy
- + For USA, UK, HKG and China, Cravache fabric is made of 100% polyester FR.

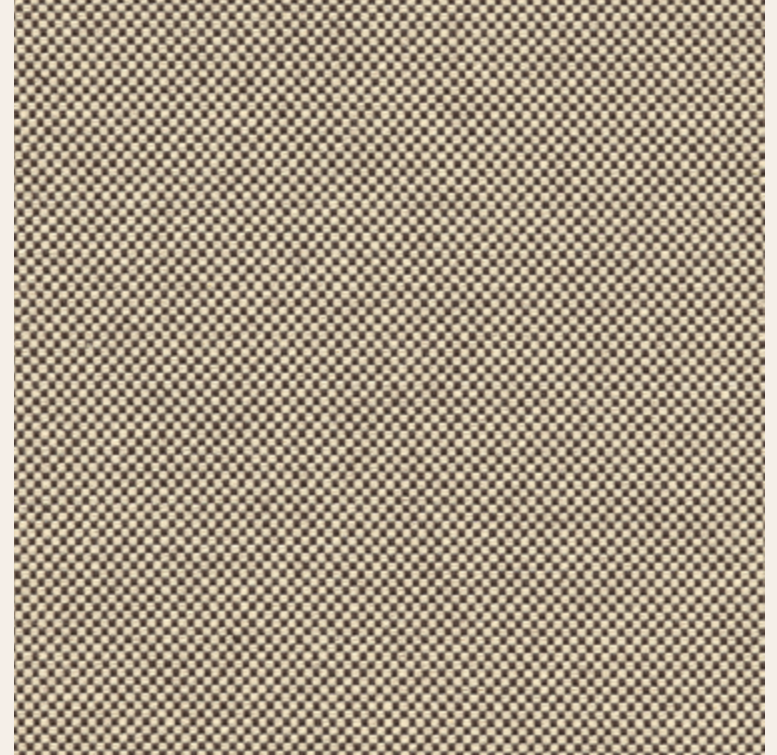
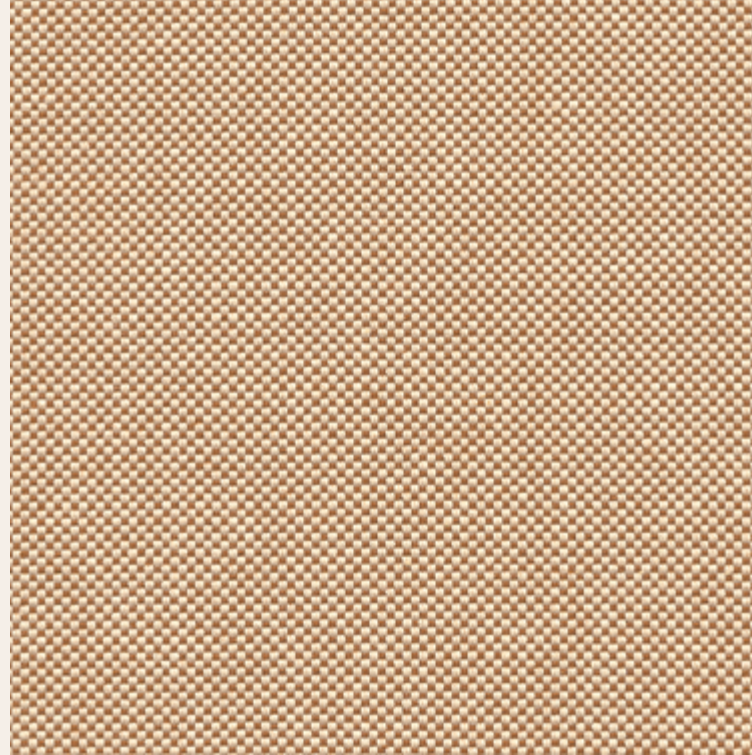

# Stones

## MATERIALS

Wood  
Leather  
Exceptional finish  
Fabrics  
**Stones**  
Metals

Ivory onyx

Arabescato Corchia marble

Breccia Aurora marble

Calacatta Carrara marble

Calacatta Viola marble

Brown Emperador marble

Port-Laurent marble

Verde Alpi marble

Romano Classico travertine

Navona travertine

Black granite



# Ivory Onyx

- + Natural - Precious - Mineral
- + Appearance: unique, beige to white coloured bands
- + Strengths: valuable, each piece is unique
- + Evolution over time: stable
- + Care: to preserve the beauty of natural stones, we recommend cleaning with a soft cloth moistened either with pure alcohol (methylated spirits) mixed with warm water, or warm water mixed with pH-neutral soap
- + Origin: Turkey



# Ivory Onyx



Example of a 120 cm-diameter table top

# Arabescato Corchia marble

- + Natural - Precious - Veined
- + Appearance: unique, with cloud effect
- + Colouring: floating white clouds on a grey background
- + Strengths: each piece is unique and all the more precious because of the rarity of the marble
- + Evolution over time: stable
- + Care: to preserve the beauty of natural stones, we recommend cleaning with a soft cloth moistened either with pure alcohol (methylated spirits) mixed with warm water, or warm water mixed with pH-neutral soap
- + Origin: Italy

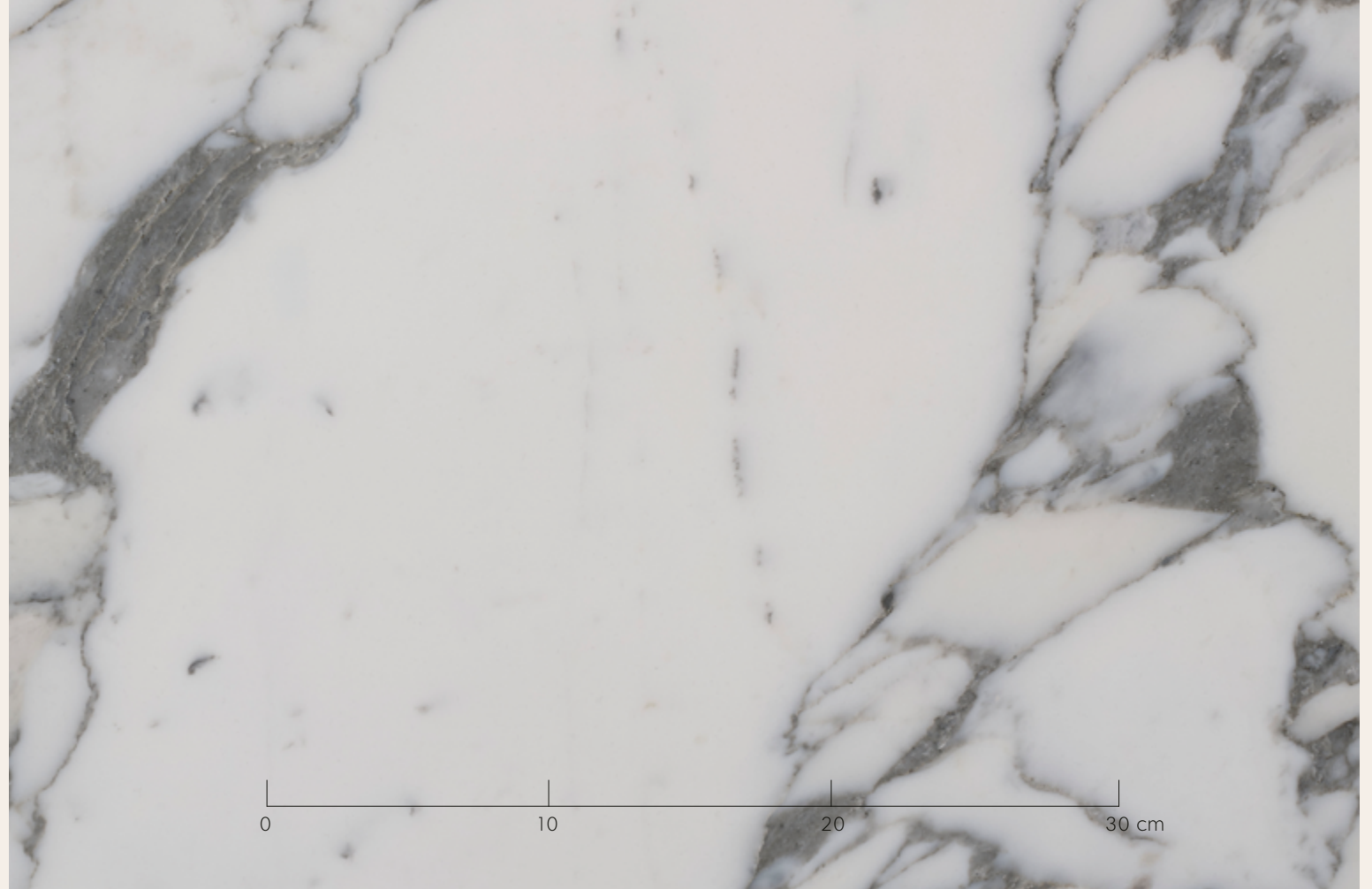

# Arabescato Corchia marble

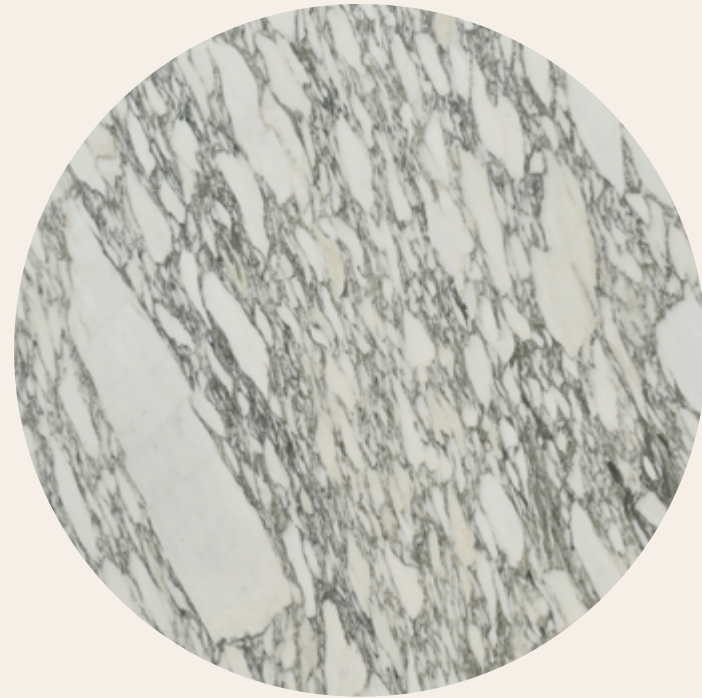
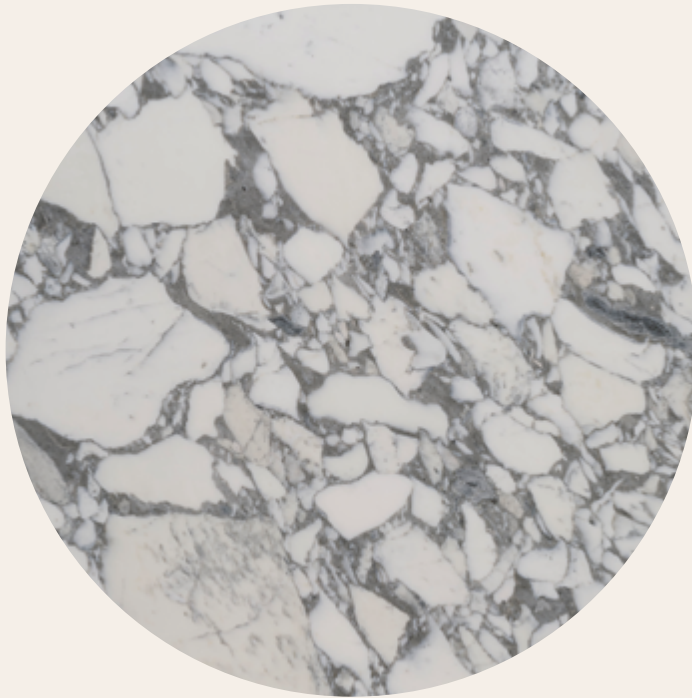

Example of a 120 cm-diameter table top



# Breccia Aurora marble

- + Natural - Precious - Veined
- + Appearance: unique, veined
- + Colouring: orange
- + Strengths: precious, each piece is unique, with different motifs
- + Evolution over time: stable
- + Care: to preserve the beauty of natural stones, we recommend cleaning with a soft cloth moistened either with pure alcohol (methylated spirits) mixed with warm water, or warm water mixed with pH-neutral soap
- + Origin: Italy

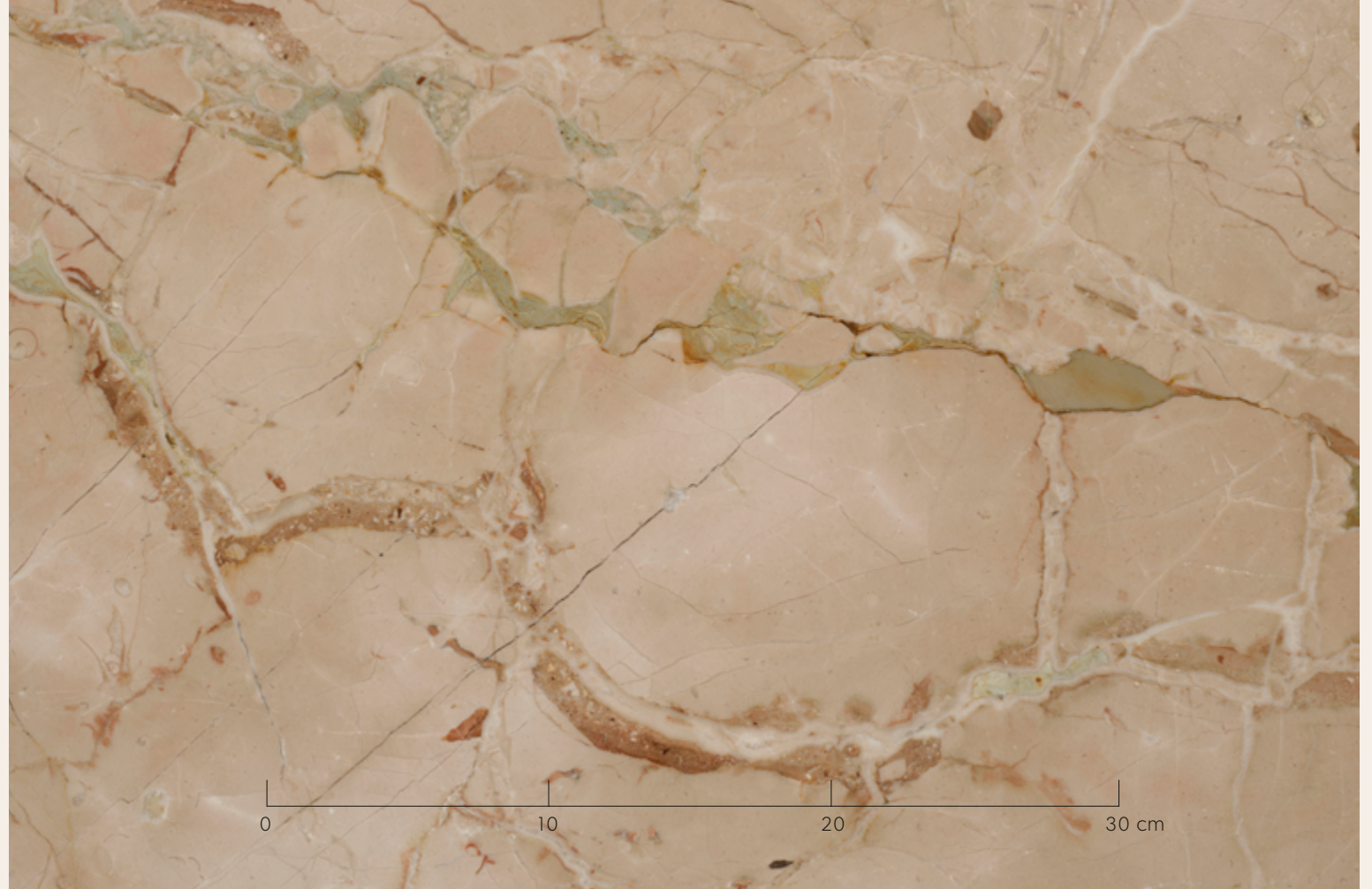

# Breccia Aurora marble

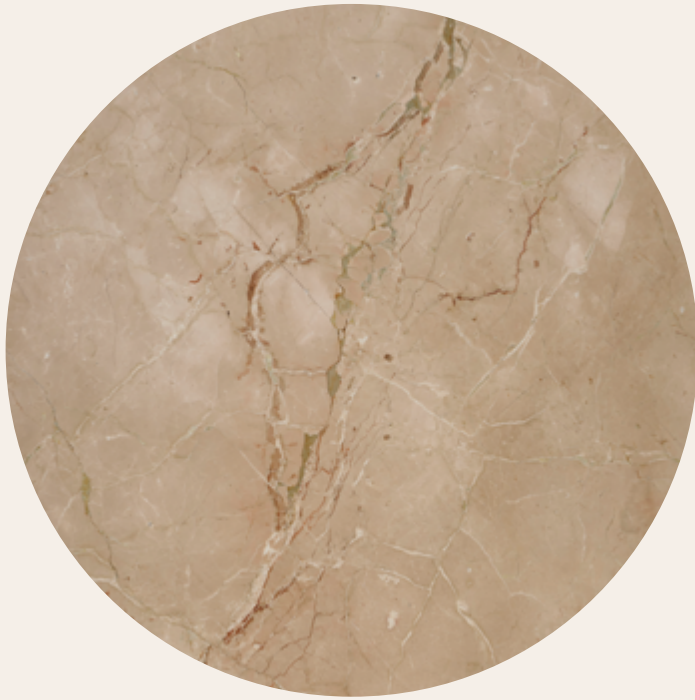

Example of a 120 cm-diameter table top

# Calacatta Carrara marble

- + Natural - Precious - Veined
- + Appearance: unique, veined
- + Colouring: grey-white
- + Strengths: precious, each piece is unique, with different motifs
- + Evolution over time: stable
- + Care: to preserve the beauty of natural stones, we recommend cleaning with a soft cloth moistened either with pure alcohol (methylated spirits) mixed with warm water, or warm water mixed with pH-neutral soap
- + Origin: Italy

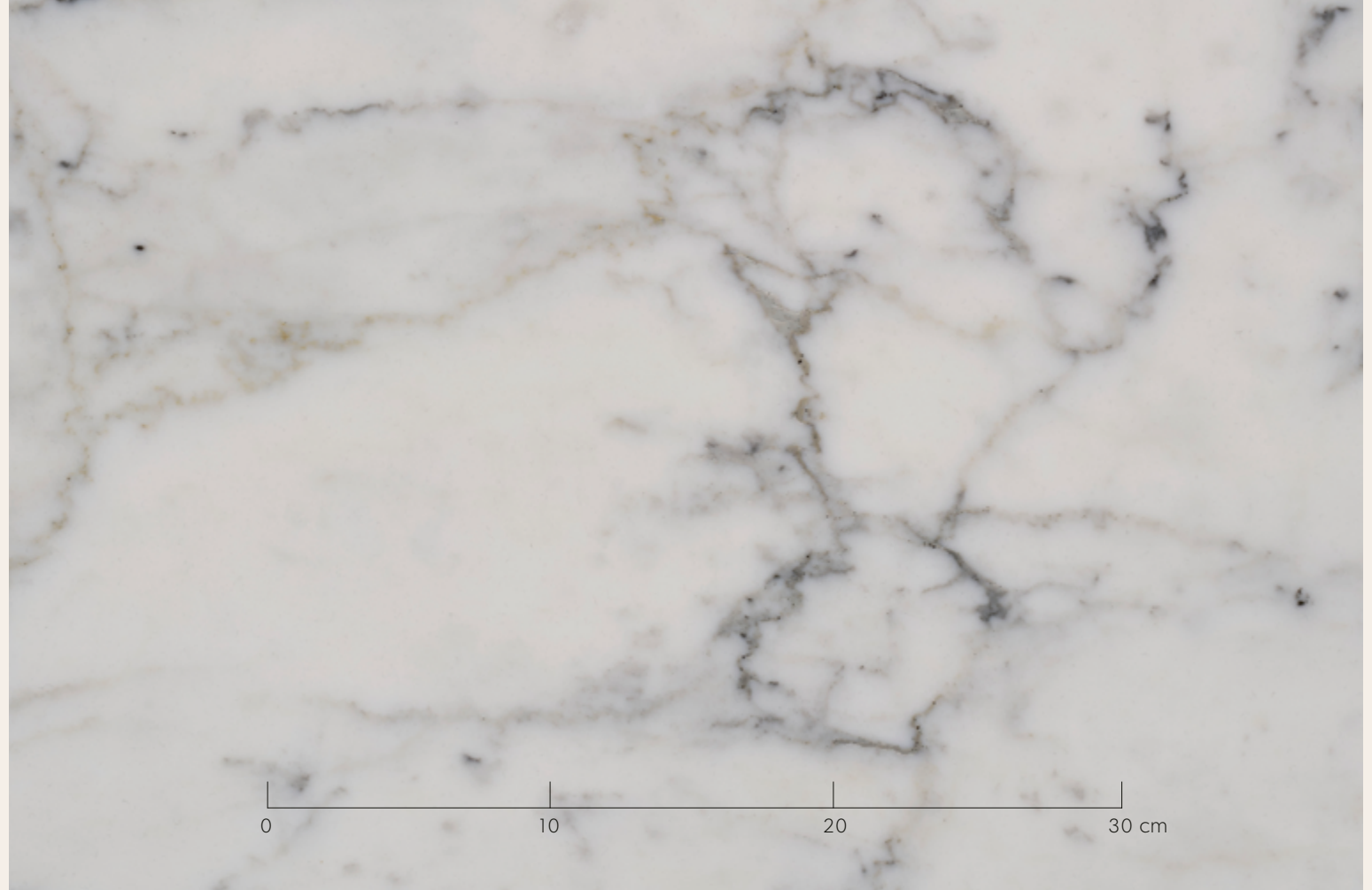

# Calacatta Carrara marble



Example of a 120 cm-diameter table top



# Calacatta Viola marble

- + Natural - Precious - Veined
- + Appearance: single, veined
- + Colouring: purple with white veins
- + Strengths: precious, each piece is unique, with different motifs
- + Evolution over time: stable
- + Care: to preserve the beauty of natural stones, we recommend cleaning with a soft cloth moistened either with pure alcohol (methylated spirits) mixed with warm water, or warm water mixed with pH-neutral soap
- + Origin: Italy



# Calacatta Viola marble

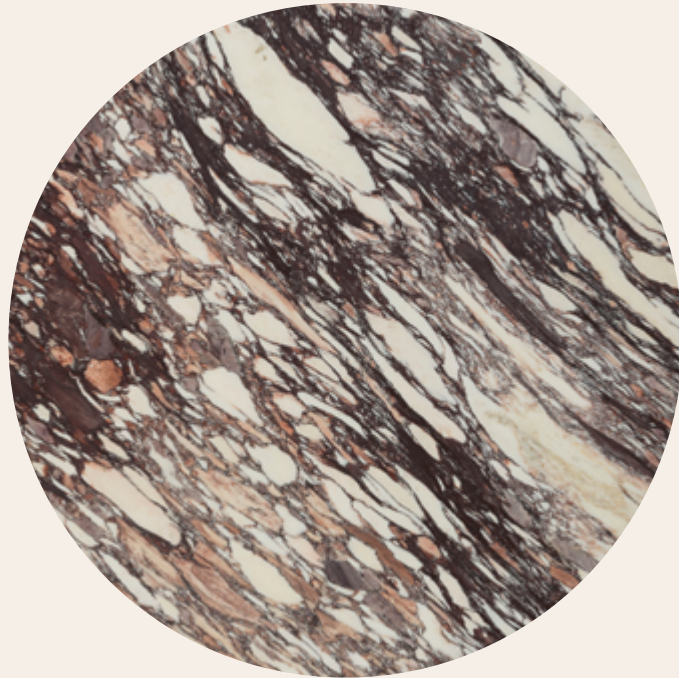

Example of a 120 cm-diameter table top



# Brown Emperador marble

- + Natural - Precious - Veined
- + Appearance: unique, veined
- + Colouring: brown with white veins
- + Strengths: precious, each piece is unique, with different motifs
- + Evolution over time: stable
- + Care: to preserve the beauty of natural stones, we recommend cleaning with a soft cloth moistened either with pure alcohol (methylated spirits) mixed with warm water, or warm water mixed with pH-neutral soap
- + Origin: Turkey and Spain

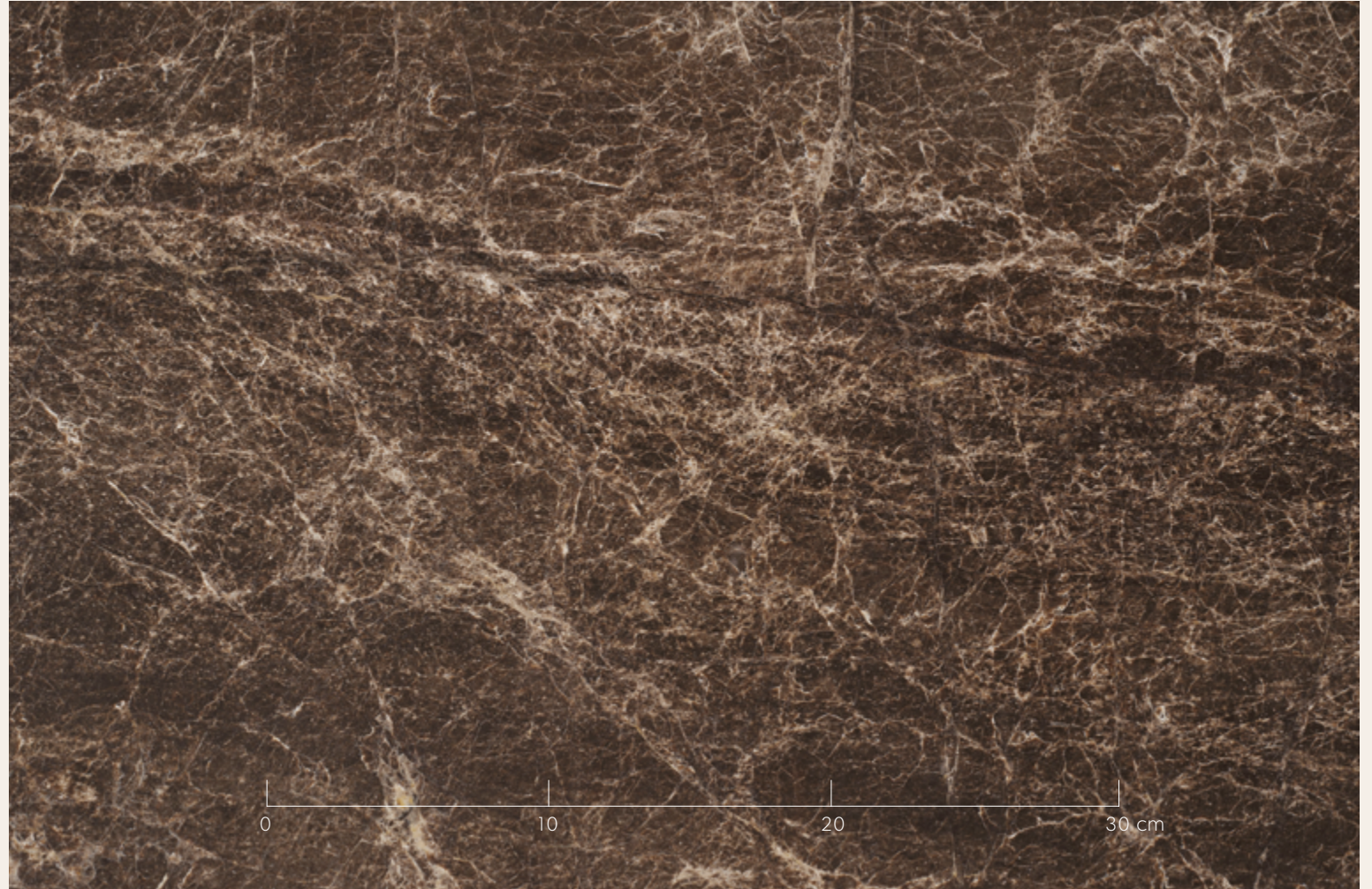



# Brown Emperador marble

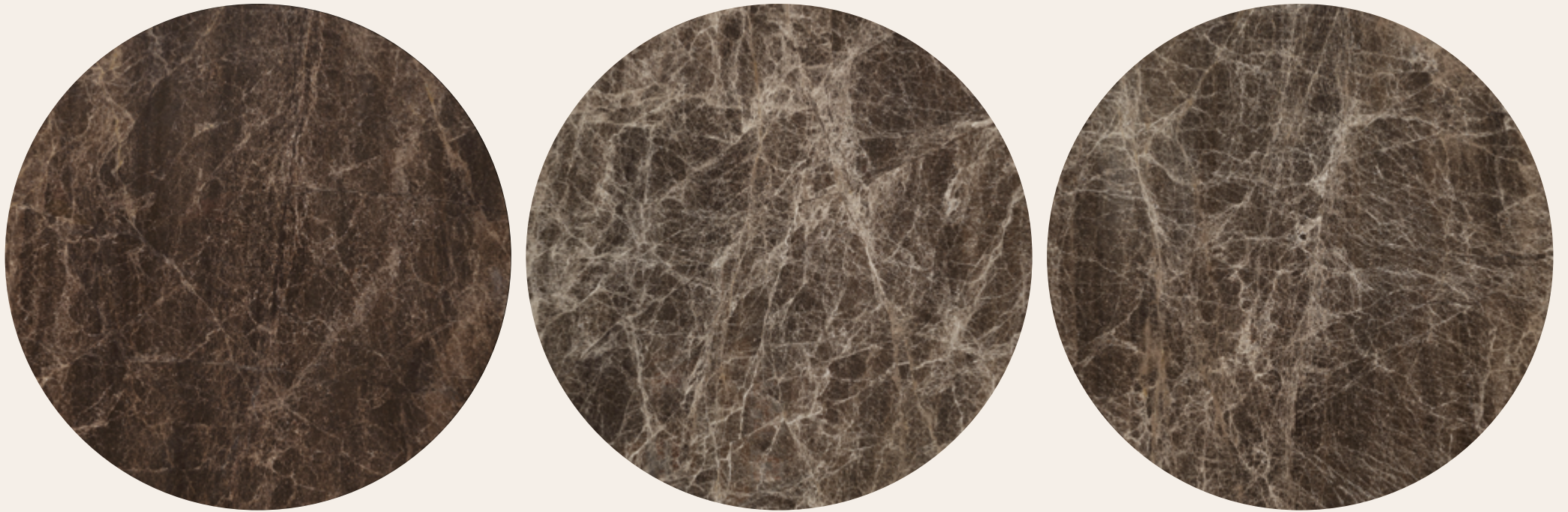

Example of a 120 cm-diameter table top

# Port-Laurent marble

- + Natural - Precious - Veined
- + Appearance: unique, veined
- + Colouring: black and gold with white veins
- + Strengths: precious, each piece is unique, with different motifs
- + Evolution over time: stable
- + Care: to preserve the beauty of natural stones, we recommend cleaning with a soft cloth moistened either with pure alcohol (methylated spirits) mixed with warm water, or warm water mixed with pH-neutral soap
- + Origin: Pakistan

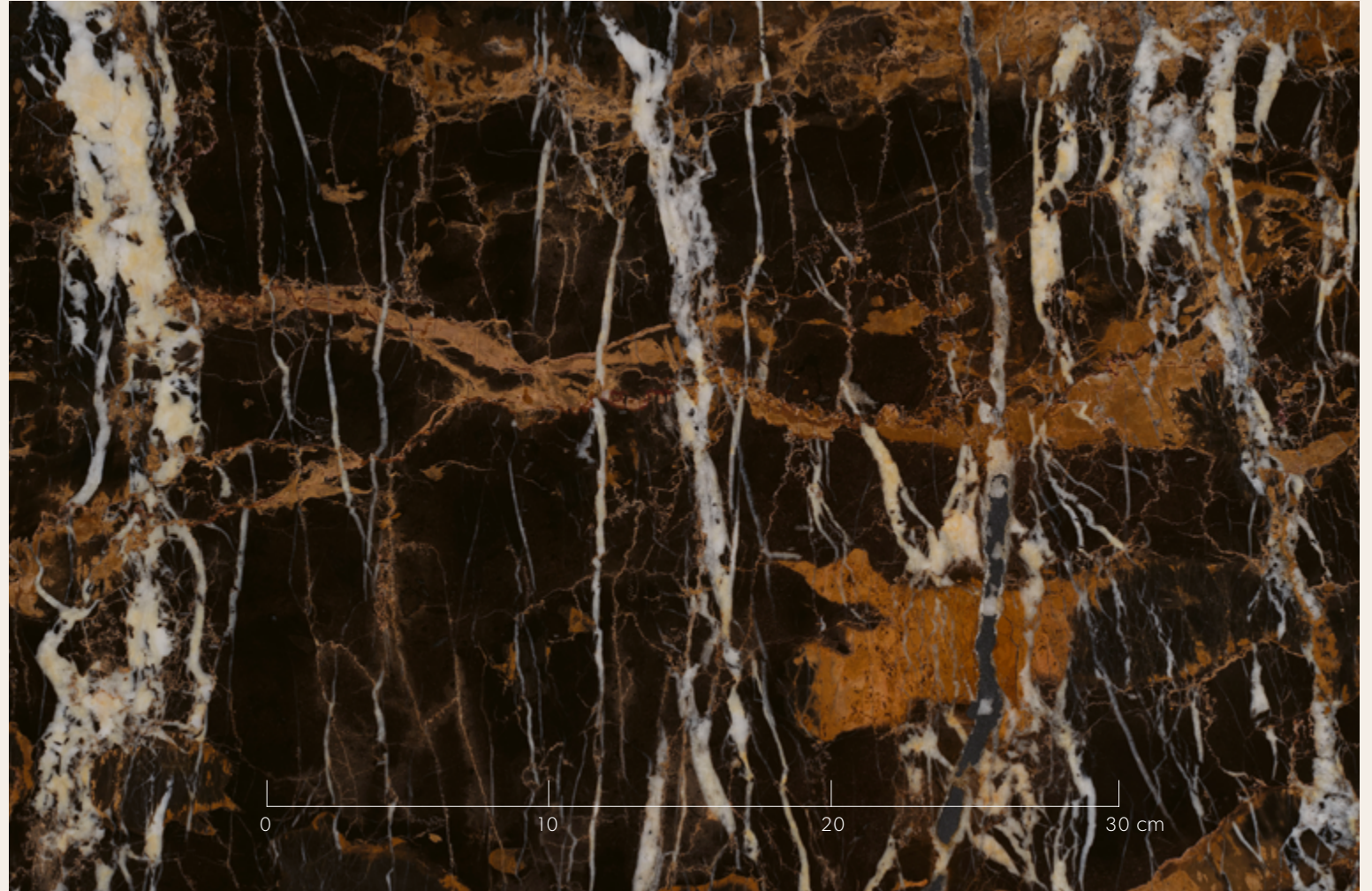



# Port-Laurent marble



Example of a 120 cm-diameter table top

# Alpi Verde marble

- + Elegant - Intense - Veined - Uniform
- + Appearance: uniform veins, intense colour
- + Colouring: deep green and white grain
- + Strengths: marble rooted in the Italian tradition, with intense colour and elegant veins
- + Evolution over time: stable
- + Care: to preserve the beauty of natural stones, we recommend cleaning with a soft cloth moistened either with pure alcohol (methylated spirits) mixed with warm water, or warm water mixed with pH-neutral soap
- + Origin: Italy





# Alpi Verde marble

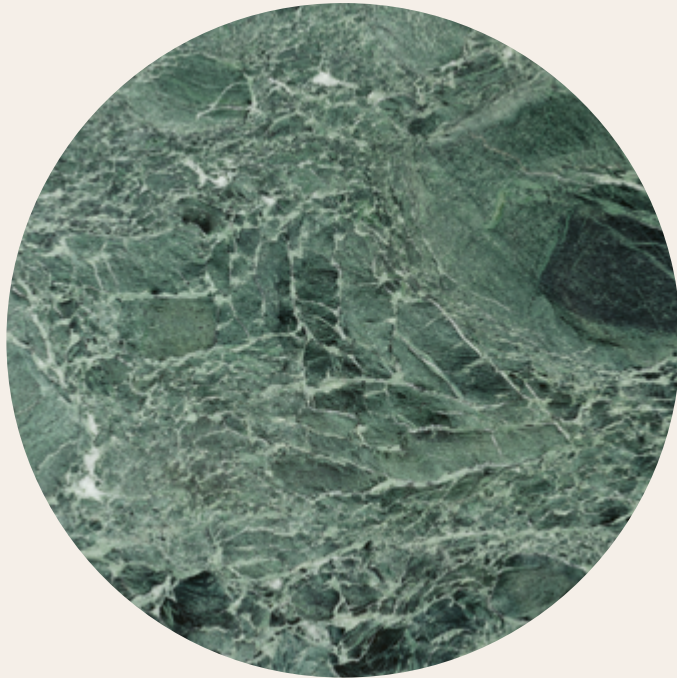
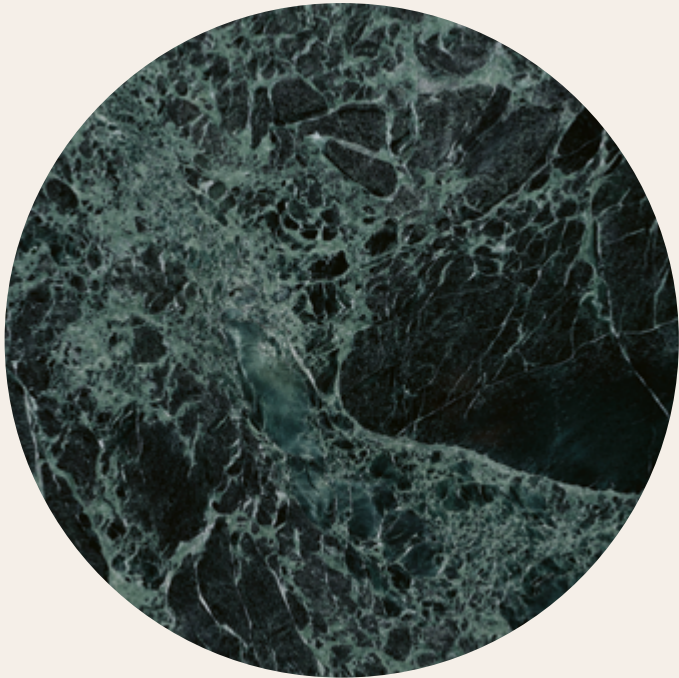

Example of a 120 cm-diameter table top



# Romano Classico travertine

- + Natural - Precious - Veined
- + Appearance: unique, veins or bands of contrasting colour which cross the stone
- + Finish: matt
- + Colouring: earthy tones, light grey veins
- + Strengths: precious, each piece is unique, with different motif
- + Evolution over time: stable
- + Care: to preserve the beauty of natural stones, we recommend cleaning with a soft cloth moistened either with pure alcohol (methylated spirits) mixed with warm water, or warm water mixed with pH-neutral soap
- + Origin: Italy

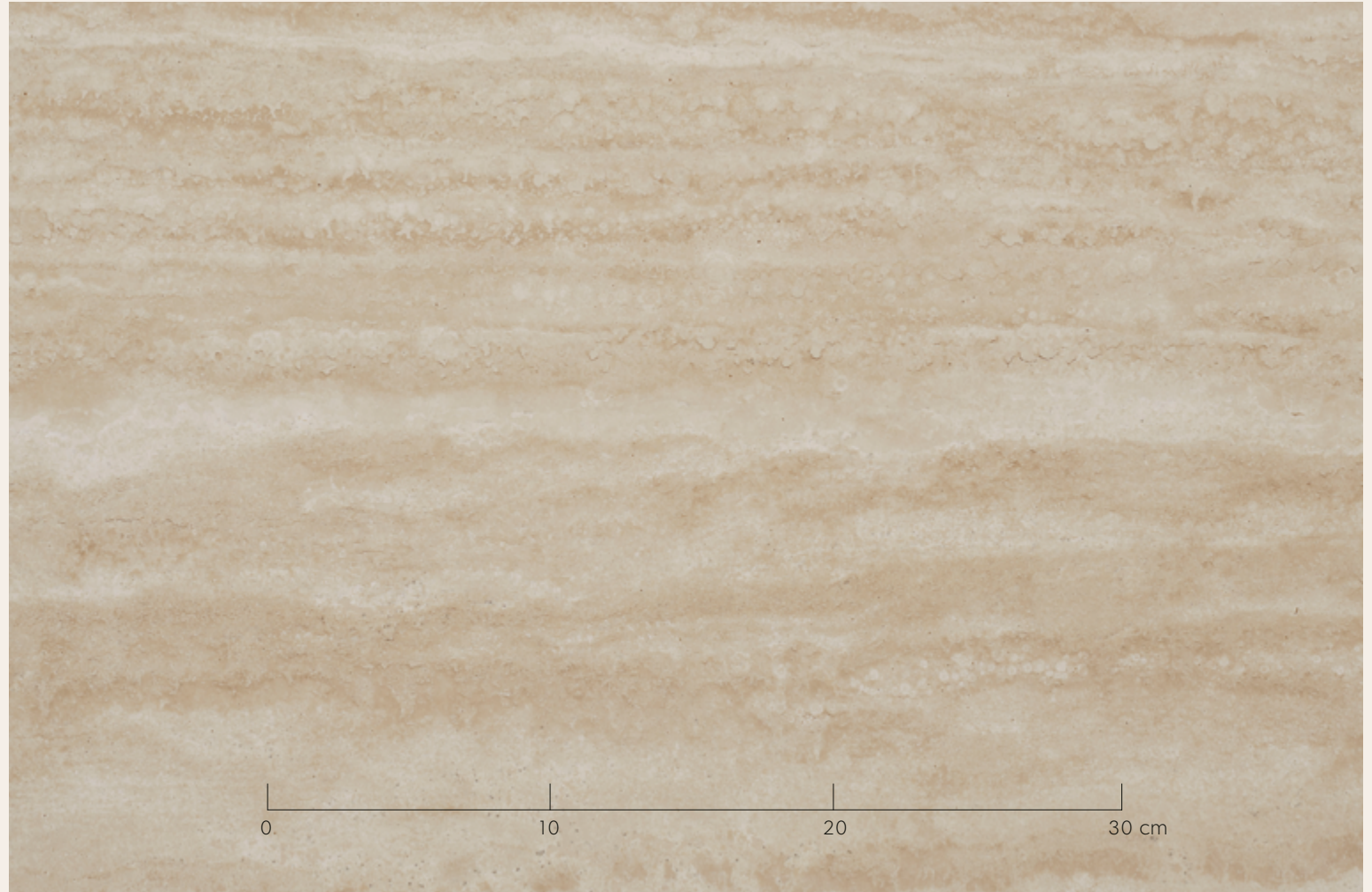

# Romano Classico travertine



Example of a 120 cm-diameter table top

# Navona travertine

- + Natural - Precious - Veined
- + Appearance: unique, veins or bands of contrasting colour which cross the stone
- + Finish: matt
- + Colouring: earthy tones, light grey veins
- + Strengths: precious, each piece is unique, with different motifs
- + Evolution over time: stable
- + Care: to preserve the beauty of natural stones, we recommend cleaning with a soft cloth moistened either with pure alcohol (methylated spirits) mixed with warm water, or warm water mixed with pH-neutral soap
- + Origin: Italy





# Navona travertine



Example of a 120 cm-diameter table top

# Black granite

- + Natural - Strong - Robust
- + Appearance: deep black
- + Strengths: scratch, shock, moisture and heat resistant
- + Evolution over time: stable
- + Care: to preserve the beauty of granite, it must be regularly wiped with a soft, non-abrasive cloth.
- + Origin: Zimbabwe



# Metals

## MATERIALS

Wood  
Leather  
Exceptional finish  
Fabrics  
Stones  
Metals

Brass

Nickel

Wrought-iron

# Brass

- + Ductile - Non-ferrous - Robust
- + Appearance: glossy
- + Strengths: corrosion resistant
- + Evolution over time: its shine will evolve over time; a thin layer of natural oxidation will appear to give it a unique patina
- + Care: to preserve the shine of the brass elements, wipe them with a soft, lint-free cloth. Alternatively, a soft sponge soaked in soapy water can be used, followed by a quick wipe down of the surface with a microfibre cloth to avoid drying marks and scratches





# Brass

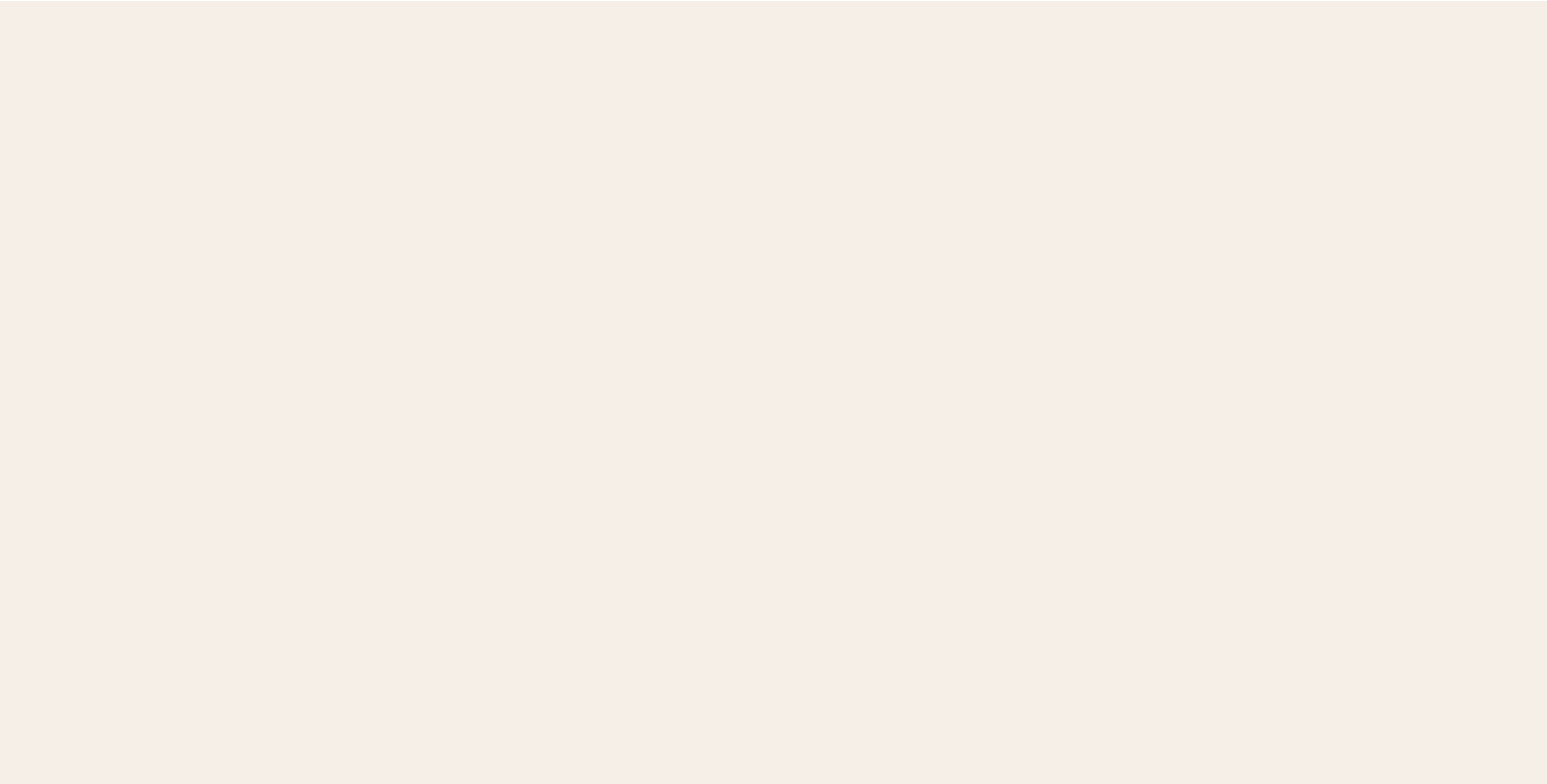

# Nickel

- + Ductile - Robust - Silver
- + Appearance: matt and satin
- + Strengths: resistant to corrosion over time
- + Evolution over time: stable
- + Care: clean with a soft cloth. Can also be cared for with a soft sponge soaked in soapy water (no steel sponges or abrasive cloths). To avoid leaving any marks, wipe down with a microfibre cloth

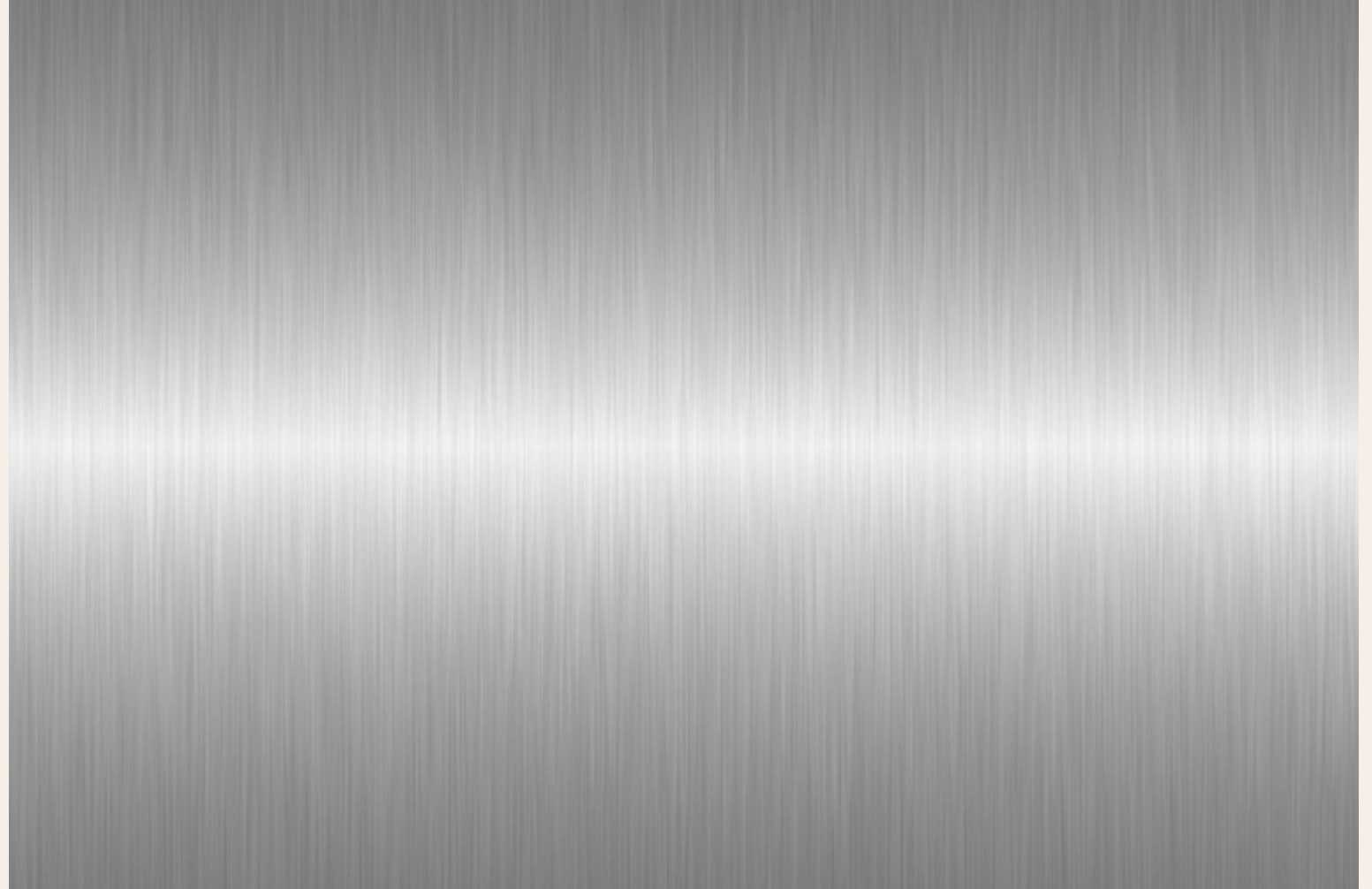

# Wrought-iron

- + Pure - Ductile - Solid
- + Appearance: metallic grey
- + Strengths: resistant to corrosion over time
- + Evolution over time: stable
- + Care: gently wipe the surface with a soft, dry duster. Avoid using a damp cloth and harsh products such as soap or detergent, as these could permanently damage the wrought-iron
- + Origin: France





Execution extreme.

Photographs: Studio des Fleurs, Pablo Lopez Luz, Alberto Strada

All rights reserved. Not to be reproduced

For professional use.

© Hermès, Paris 2024